

OPERATION, SERVICE AND PARTS MANUAL

**J1C/MJ15
Gas Fryers**



 **Frymaster[®]**

Frymaster L.L.C., 8700 Line Avenue 71106, PO Box 51000, Shreveport, Louisiana 71135-1000
318-865-1711 FAX 813-862-2394

Printed in the U.S.A.

SERVICE HOTLINE
1-800-551-8633

Price \$4.00
819-5355 04/94



WARNING

IMPROPER INSTALLATION, ADJUSTMENT, ALTERATION, SERVICE OR MAINTENANCE CAN CAUSE PROPERTY DAMAGE, INJURY OR DEATH. READ THE INSTALLATION, OPERATING AND MAINTENANCE INSTRUCTIONS THOROUGHLY BEFORE INSTALLING OR SERVICING THIS EQUIPMENT.

WARNING

FOR YOUR SAFETY, DO NOT STORE OR USE GASOLINE OR OTHER FLAMMABLE VAPORS AND LIQUIDS IN THE VICINITY OF THIS OR ANY OTHER APPLIANCE.

POST IN PROMINENT LOCATION THE INSTRUCTIONS TO BE FOLLOWED IN THE EVENT THE USER SMELLS GAS. THIS INFORMATION SHALL BE OBTAINED BY CONSULTING THE LOCAL GAS SUPPLIER.

THE EQUIPMENT IS TO BE INSTALLED TO COMPLY WITH THE BASIC PLUMBING CODE OF THE BUILDING OFFICIALS AND CODE ADMINISTRATORS INTERNATIONAL, INC. (BOCA) AND THE FOOD SERVICE SANITATION MANUAL OF THE FOOD AND DRUG ADMINISTRATION (FDA).

WARNING

THIS PRODUCT CONTAINS CHEMICALS KNOWN TO THE STATE OF CALIFORNIA TO CAUSE CANCER AND/OR BIRTH DEFECTS OR OTHER REPRODUCTIVE HARM.

¹Operation, ²installation and ³servicing of this product could expose you to airborne particles of glasswool fibers and/or carbon monoxide. Inhalation of airborne particles of glasswool fibers is known to the State of California to cause cancer. Inhalation of carbon monoxide is known to the State of California to cause birth defects or other reproductive harm.

NOTICE

The Commonwealth of Massachusetts requires any and all gas products to be installed by a licensed plumber or pipe fitter.

J1C/MJ15 SERIES FRYERS

TABLE OF CONTENTS

<i>SECTION</i>	<i>DESCRIPTION</i>	<i>PAGE #</i>
1	Parts Ordering/Service Information	1
2	Important Information	1
3	Installation Instructions	2
4	Operating Instructions	4
5	Ventilation and Clearance	6
6	Draining and Filtering Instructions	6
7	Preventive Maintenance	8
8	J1C/MJ15 Series Components	9
9	Burner Components	10
10	Accessories	11
11	Thermostat Components	12
12	Frypot Components	13
13	Fryer Troubleshooting Guide	14
14	Service Procedures	16
15	Wiring Diagrams	21
16	Fryer Specification Sheet	22
	United States Limited Warranty - The J1C/MJ15 Series Fryer	23

1. PARTS ORDERING/SERVICE INFORMATION

Parts orders must be placed directly with your local Frymaster Parts Distributor. A list of Frymaster Parts Distributors was included with the fryers when shipped from the factory. If you do not have access to this list, please contact the Frymaster Service Department at 1-800-551-8633 or 1-318-865-1711.

To help speed your order, the following information is required:

Model Number: _____

Serial Number: _____

Type of Gas or Voltage: _____

Part Number: _____

Service information may be obtained by calling your local Factory Authorized Service Center. A list of these agencies was packed with your fryer. Service information may also be obtained by calling the Frymaster Service Department. When calling, please have the following information available:

Model Number: _____

Serial Number: _____

Type of Gas or Voltage: _____

Nature of Service Problem: _____

And other information that may be helpful in solving your service problem.

PARTS ORDERING/SERVICE INFORMATION CANADA -- Garland Commercial Ranges, Ltd., 1177 Kamato Road, Mississauga, Ontario L4W1X4.

NOTE: RETAIN AND STORE THIS MANUAL IN A SAFE PLACE FOR FUTURE USE. ADDITIONAL COPIES MAY BE OBTAINED FROM YOUR AUTHORIZED SERVICE CENTER.

2. IMPORTANT INFORMATION

INTRODUCTION

The J1C/MJ15 Series are deep-well, open-pot fryers designed for cooking fried products. These models are available in full pot arrangement manufactured to operate on the type of gas specified by the user (natural, propane or manufactured gas). The instructions contained in this manual should be read thoroughly before attempting to operate these fryers.

This equipment is made in America and has American sizes of hardware. All hardware metric conversions are approximate and can vary in size.

OPERATING, INSTALLATION, AND SERVICE PERSONNEL

Operating information for Frymaster equipment has been prepared for use by qualified and/or authorized operating personnel.

All installation and service on Frymaster equipment must be performed by qualified, certified, licensed, and/or authorized installation or service personnel.

DEFINITIONS

QUALIFIED AND/OR AUTHORIZED OPERATING PERSONNEL

Qualified or authorized operating personnel are those who have carefully read the information in this manual and have familiarized themselves with the equipment functions or have had previous experience with the operation of equipment covered in this manual.

QUALIFIED INSTALLATION PERSONNEL

Qualified installation personnel are: individuals, a firm, corporation, or company which either in person or through a representative are engaged in, and are responsible for the installation of gas-fired appliances. Qualified installation personnel must be experienced in such work, be familiar with all gas precautions required, and have complied with all requirements of state and local codes.

QUALIFIED SERVICE PERSONNEL

Qualified service personnel are those familiar with Frymaster equipment and have been authorized by The Frymaster Corporation. All authorized service personnel are required to be equipped with a complete set of service parts manuals and stock a minimum amount of parts for Frymaster equipment.

A list of Frymaster Factory Authorized Service Centers was included with the fryer when shipped from the factory. If you do not have access to this list, please contact the Frymaster Customer Service Department using the number listed on the front of this manual. Failure to use qualified service personnel will void the Frymaster warranty.

SHIPPING DAMAGE CLAIM PROCEDURE

For your protection, please note that the Frymaster equipment was carefully inspected and packed by skilled personnel before leaving the factory. The transportation company assumes full responsibility for safe delivery upon acceptance of the equipment.

If the equipment arrives damaged:

- a. FILE CLAIM FOR DAMAGES IMMEDIATELY - regardless of extent of damage.
- b. VISIBLE DAMAGE OR LOSS - be sure this is noted on the freight bill or express receipt and is signed by the person making the delivery.
- c. CONCEALED LOSS OR DAMAGE - if damage is unnoticed until equipment is unpacked, notify freight company or carrier immediately, and file a "concealed damage" claim. This should be done within 15 days of date of delivery. Be sure to retain container for inspection.

FRYMASTER DOES NOT ASSUME RESPONSIBILITY FOR DAMAGE OR LOSS INCURRED IN TRANSIT.

3. INSTALLATION INSTRUCTIONS

PROPER INSTALLATION IS ESSENTIAL FOR TROUBLE-FREE OPERATION. ANY ALTERATIONS TO THE EQUIPMENT VOIDS THE FRYMASTER WARRANTY.

Before installing the new equipment, inspect the equipment carefully for visible and concealed damage. See Section 2.

The fryer installation area must allow for a 6-inch (15 cm) clearance at both sides and back next to combustible materials; 0 inches for non-combustible materials. A minimum of 24 inches (61 cm) should be provided at the front of the fryer for servicing and proper operation. Air for combustion enters the unit below the cabinet base. **DO NOT BLOCK THE AREA AROUND THE BASE OR UNDER THE FRYERS.**

THE APPLIANCE AREA MUST BE KEPT FREE AND CLEAR OF COMBUSTIBLES.

WARNING

DO NOT ATTACH APRON DRAIN BOARD TO A SINGLE FRYER. THE FRYER MAY BECOME UNSTABLE, TIP OVER, AND CAUSE INJURY.

FRYER EQUIPPED WITH CASTERS

- a. Frymaster fryers equipped with casters must be installed in a manner that will allow the fryer drain line to drain properly. See Caster Installation Instruction sheet included with fryer literature package.
- b. Adequate means must be provided to avoid the splashing of hot liquid without depending on the gas connector and any quick-disconnect device or its associated piping. This can be accomplished by attaching restraining chains/cables to the outside of the front casters and securing the chains/cables to the floor.
- c. Ensure installation is made with a gas connector that complies with the latest editions of the Standard for Connectors for Movable Gas Appliances ANSI Z21.69 and Addenda, Z21.69, and a quick-disconnect device that complies with the latest edition of the Standard for Quick-Disconnect Devices for Use With Gas Fuel, ANSI Z21.41.

NATIONAL CODE REQUIREMENTS

Frymaster gas fryers are manufactured to use the type gas specified on the rating plate located on the fryer door(s). When installing gas fryers in the United States, the installation must conform with the latest edition of the National Fuel Gas Code, ANSI Z223.1. In addition, all local codes must be followed. In Canada, installation must conform with the latest edition of Standard CAN/CGA-B149.1 or .2, "Installation Codes for Gas Burning Appliances & Equipment".

When installing any type of gas-fired commercial kitchen equipment, Standard No. 96 and Standard 211 of the National Fire Protection Association must be followed implicitly. A copy of the standards may be obtained from the National Protection Association, Battery March Park, Quincy, Massachusetts 02269.

GAS CONNECTIONS AND PIPE SIZE

The size of the fryer gas supply pipe is very important. If the pipe is too small, the gas pressure at the burner manifold will be low. This will cause slow recovery and delayed ignition. The incoming gas supply line should be a minimum of 1". All single J1C/MJ15 fryers require a ½" connection. Batteries of 2 and 3 MJ15 fryers require a 1" connection.

NOTE: Runs of more than 20 feet and more than 4 fittings or elbows require an increase of one pipe size. For gases with heating values less than 800 BTU's per cubic foot, increase the pipe size by 1 size. For LP gases, the next smaller pipe size may be used. If in doubt about pipe size, consult the local gas company.

CAUTION: Before connecting the new pipe to the J1C/MJ15 series fryers, the pipe **MUST** be blown out thoroughly to remove all foreign particles. Foreign particles in the burner and controls may cause improper and dangerous operation.

When using thread compound, use very small amounts on male threads only. Use a pipe thread compound that will withstand the chemical action of LP gases (Loctite PST 56765). **DO NOT** apply compound to the first 2 threads. This will prevent clogging of the burner orifices and control valve.

Make sure the installer checks all gas plumbing with a soap solution for leaks. **DO NOT** use matches, candles, or other ignition materials.

The fryers and individual shut-off valves must be disconnected from the gas supply piping system during any pressure testing of the gas supply piping at pressures equal to or greater than ½ psig (3.45 kPa) (13.84 in W.C.).

The fryers must be isolated from the gas supply piping system by closing its individual manual shutoff valve during any pressure testing of the gas supply piping system at test pressures equal to or less than ½ psig (3.45 kPa).

AFTER FRYER IS UNDER FRY STATION EXHAUST HOOD

CAUTION: **DO NOT CONNECT FRYER TO GAS SUPPLY BEFORE COMPLETING STEPS a. THROUGH c.**

- a. To level fryers equipped with legs, screw out the legs approximately 1 inch. Adjust the legs so the fryer is level and properly elevated under

the exhaust hood. For fryers with casters, there are no built-in leveling devices. The floor where the fryers are installed must be level.

- b. Check the serial plate on the fryer door to determine if fryer burner is set up for the proper gas type before connecting the quick disconnect or piping from the building gas supply pipe.
 - 1) Minimum incoming gas pressure for NATURAL GAS is 6 in. W.C. (1.49 kPa). Maximum incoming gas pressure for NATURAL GAS is 14 in. W.C. (3.49 kPa).
 - 2) Minimum incoming gas pressure for LP GAS is 11 in. W.C. (2.74 kPa). Maximum incoming gas pressure for LP GAS is 14 in. W.C. (3.49 kPa).
- c. Connect the quick disconnect hose or pipe from the building gas pipe to the fryer quick disconnect fitting under the front of the fryer or pipe at the rear of the fryer.
- d. Close the fryer drain valve and fill frypot with water and boil-out solution to the OIL-LEVEL line at the back of the frypot. Light the fryer. Refer to "Lighting Instructions" and "Boiling Instructions" in this manual.
- e. Test all piping for gas leaks. A soap solution should be used for this purpose. Never use a flame.

WARNING: IF GAS ODORS ARE DETECTED, SHUT OFF THE FRYER GAS SUPPLY AT THE MAIN SHUT-OFF VALVE, AND CONTACT THE LOCAL GAS COMPANY OR AUTHORIZED SERVICE AGENCY FOR SERVICE.

- f. Burner operating gas pressure can be checked at this time. See "Check Burner Manifold Pressure" in Section 7 of this manual.
 - 1) Burner manifold pressure for NATURAL GAS must be 4.0 in. W.C. (1.0 kPa).
 - 2) Burner manifold pressure for LP GAS must be 10.0 in. W.C. (2.50 kPa).

NOTE: This should be checked by the local gas company or an authorized service agent.

4. OPERATING INSTRUCTIONS

WARNING: WHEN FRYERS ARE IN USE, FRYER RESTRAINT CHAINS/CABLES MUST BE INSTALLED IN ORDER TO PREVENT THE FRYER FROM TIPPING AND SPLASHING HOT LIQUID.

THESE INSTRUCTIONS APPLY FOR FIRST-TIME USE OF THE FRYER

BOILING OUT THE FRYPOTS

Clean new frypots as follows before filling with shortening:

- Before operating the burner, close the fryer drain valve and fill empty frypot with a mixture of cold water and boil-out solution. Fill frypot to the OIL-LEVEL line.
- To light the fryer, follow "Lighting Instructions" in this manual or on the back of the fryer door.
- Set thermostat knob to 275°F (135°C) and turn the fryer gas valve knob to the ON position.
- Simmer the solution for 1 hour. **CAUTION:** Never leave the fryer unattended during the boil-out procedure. Turn the gas valve knob to the PILOT position occasionally to ensure the boil-out solution does not foam and overflow.
- After the solution simmers for 1 hour, turn the fryer gas valve knob to the PILOT position and allow the solution to cool.
- Add 1 gallon (3.8 liters) of cold water and stir. Drain the solution into a suitable container and clean the frypot thoroughly.
- Close the drain valve and fill the frypot with clean water. Using a frypot cleaning brush, rinse the frypot twice and wipe with a clean, dry towel after draining the rinse water.

CAUTION: REMOVE ALL DROPS OF WATER FROM THE FRYPOT BEFORE FILLING THE FRYPOT WITH SHORTENING.

FILLING WITH SHORTENING

J1C/MJ15 Series fryers have a minimum of 15 lbs. (8 liters) and a maximum of 20 lbs. (11 liters) of shortening capacity.

- Make sure the fryer gas valve is in the OFF or PILOT position.
- Close the frypot drain valve. Remove the basket support rack, if required.
- Fill the frypot to the OIL-LEVEL line. When solid shortening is used, make sure it is packed down into the frypot cold zone.
- To melt solid shortening without scorching, alternately turn the burner ON for about 3 seconds and OFF for about 10 seconds until the shortening is melted. If you see smoke during this process, you are heating too fast and scorching the shortening. This step is not needed if you use liquid shortening.
- See "Lighting Instructions" after filling frypot with shortening.

LIGHTING INSTRUCTIONS -- J1C/MJ15 SERIES FRYER

WARNING: FRYPOT MUST BE FILLED WITH WATER OR SHORTENING BEFORE LIGHTING.

- Turn the thermostat knob to the required frying temperature.
- Turn the gas valve knob to the PILOT position. See Figure 1.

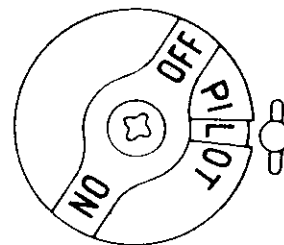

Fig. 1

- Push the knob in, light the pilot and continue to hold the knob in for about 60 seconds after the flame appears on the pilot. Release the knob. The pilot should remain lit.

CAUTION: If the pilot does not remain lit, wait 5 minutes before attempting to light or relight.

- After the pilot remains lit, turn the knob counter-clockwise to the ON position. See Figure 2.

- e. The burner will now light and is controllable by the thermostat.

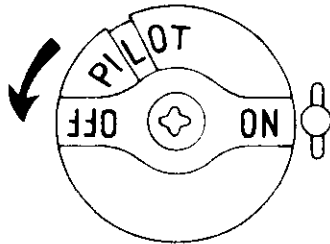

Fig. 2

CAUTION: If the pilot and main burner go out, the fryer(s) MUST be completely shut down at least 5 minutes before lighting.

ACCESSING FRYERS FOR SERVICING

WARNING: Moving a fryer filled with hot shortening may cause splattering of hot shortening. Extreme care must be exercised. It is recommended that the operator or servicer follow the draining instructions of this manual before attempting to relocate the fryer.

- Disconnect the quick-disconnect hose.
- Remove restraining devices typically applied to the bottom or the back of the fryer.
- Relocate the fryer for service accessibility.
- After servicing is complete, reconnect the quick-disconnect hose. Attach the restraining devices.

SHUTTING FRYER(S) OFF FOR SHORT PERIODS

- Open fryer door(s) and turn gas valve knob(s) to the PILOT position. See Figure 1.
- Depress gas valve knob(s) and turn slightly clockwise.
- Release and continue turning clockwise to the OFF position. See Figure 3.

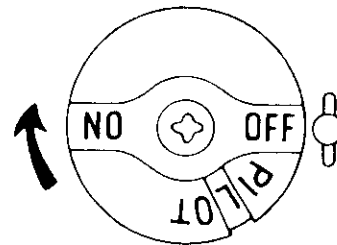

Fig. 3

- Place frypot covers in place if equipped.

5. VENTILATION AND CLEARANCE

- One of the most important considerations of efficient fryer operation is ventilation. Make sure the fryer is installed so that products of combustion are removed efficiently and the kitchen ventilation system does not produce drafts that interfere with proper burner operation. The fryer flue opening must not be placed close to the intake of the exhaust fan.
- The fryer must never have the flue extended in a "chimney" fashion. An extended flue will change the combustion characteristics of the fryer causing longer recovery time. This frequently causes delayed ignition. To provide air flow necessary for good combustion and burner operation, the areas surrounding the fryer front, sides and rear must be kept clear and unobstructed.
- The fryer(s) must be installed in an area with adequate air supply and ventilation.
- Many operators do not realize that the finest ventilation system will break down if improperly maintained. The duct system, the hood, and the filter bank must be cleaned on a regular basis and kept grease-free.
- Adequate distances must be maintained from the flue outlet of the fryer to the lower edge of the filter bank. Install filters at an angle of 45°. Place a drip tray beneath the lowest edge of the filter. For U.S. installation, NFPA Standard No. 96 states that, "A minimum distance of 18 in. (450 mm) should be maintained between the flue outlet and the lower edge of the grease filter". We recommend that the MINIMUM DISTANCE BE 24 IN. (600 mm) FROM THE FLUE OUTLET TO THE BOTTOM EDGE OF THE FILTER WHEN THE APPLIANCE CONSUMES MORE THAN 120,000 BTU PER HOUR. Information on construction and installation of ventilating hoods can be found in the NFPA Standard above. A copy of this standard may be obtained from the National Fire Protection Association, Battery March Park, Quincy, Mass. 02269.

6. DRAINING AND FILTERING INSTRUCTIONS

WARNING: Use care when draining and filtering shortening to avoid serious burns.

FILTERING

The following procedure is recommended to drain and filter your shortening when a filter machine is not available.

- a. Turn the fryer gas valve knob to PILOT. Screw the drain pipe (provided with fryer) into the drain valve. Make sure the drain pipe is firmly screwed into the drain valve and that the curved end is pointing down. See Figure 4.

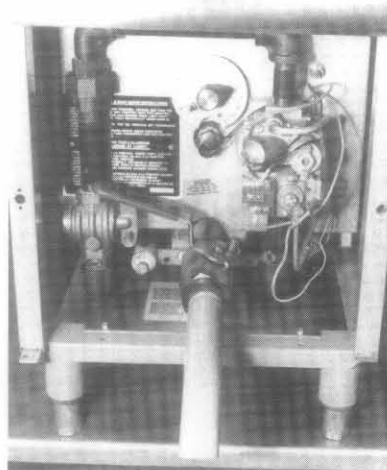

Fig. 4

- b. Position a metal container with sealable cover under the drain pipe. The metal container must be able to withstand the hot shortening and hold hot liquids. Frymaster recommends that a Frymaster filter cone holder and filter cone be used when a filter machine is not available. If you are using the Frymaster filter cone holder and cone, be sure that the cone holder rests securely on the metal container.
- c. Open the drain valve slowly to avoid splattering. If splattering occurs, exercise extreme caution.
- d. If the drain valve becomes clogged with food particles, you may wish to use the Fryer's Friend (poker-like tool). Use this tool from the inside of the frypot ONLY. See Figure 5. Carefully grip the tool as far as possible away from the shortening in the frypot. DO NOT hammer on the drain valve, this damages the drain valve ball. DO NOT insert the tool into the front of the drain to

unclog the valve, hot shortening will rush out creating an extreme hazard.

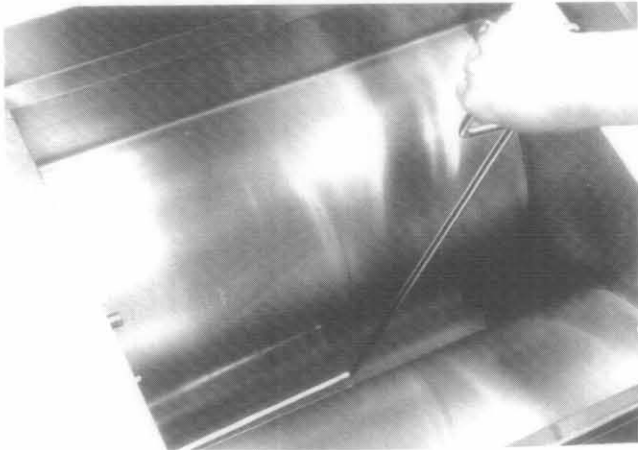

Fig. 5

CAUTION: Allow the shortening to cool to 100°F (38°C) or lower before transporting the container and removing the drain pipe. Shortening temperature of 140°F (60°C) or higher will result in severe burns.

FOR SAFE, CONVENIENT DRAINING AND DISPOSING OF USED SHORTENING, FRYMASTER RECOMMENDS THE USE OF THE FRYMASTER SHORTENING DISPOSAL UNIT (SDU). THE SDU IS AVAILABLE THROUGH YOUR LOCAL DISTRIBUTOR.

- e. After draining the shortening, clean all food particles and residual shortening from the frypot before refilling.
- f. Close the drain valve and refill the frypot with clean, filtered shortening.

7. PREVENTIVE MAINTENANCE

To keep your fryer operating efficiently and trouble free, perform the following routine maintenance procedures:

CHECK BURNER MANIFOLD PRESSURE - Every 4 to 6 Months.

1. Turn the gas valve knob to the PILOT position.
2. Remove the small pipe plug from the burner manifold gas pressure test port and install a water manometer or water column pressure gage hose fitting in its place.

3. Connect the manometer or gage hose to the fitting.

CAUTION: The frypot must be filled with water or shortening before proceeding to the next step.

4. Turn the fryer thermostat knob to a normal cooking temperature setting and the gas valve knob to the ON position.

5. The burner should come on and the manometer or pressure gage should indicate burner manifold pressure. 4.0 in. W.C. (0.99kPa) Natural Gas, 10.0 in. W.C. (2.49kPa) LP Gas.

6. If the burner manifold pressure does not meet these specifications, remove the slotted cap screw from the top of the gas valve regulator and turn the adjusting screw to obtain the correct pressure (clockwise to increase, counter-clockwise to decrease).

NOTE: The cap screw is located where the vent tube enters the gas valve.

7. After adjusting the manifold pressure to the correct specifications, reinstall the regulator cap screw, turn the gas valve knob to the PILOT position.
8. Remove the manometer or pressure gage hose fitting from the burner manifold pressure test port and reinstall the pipe plug.
9. Turn the gas valve knob to the ON position to put the fryer back into operation.

CHECK THERMOSTAT CALIBRATION -- Every 4 to 6 Months.

1. Insert a good grade thermometer or pyrometer into the center of the frypot approximately 2 to 3 inches (5 to 7 cm) deep.

2. With the burner operating, turn the thermostat knob to a normal cooking temperature setting and allow the temperature to stabilize.

3. Allow the burner to cycle on and off 3 times after the shortening temperature has stabilized. As the burner comes on the fourth time, check the shortening temperature. If the thermometer and thermostat knob agree within 5° F (3° C), no further action is required.

CHECK ALIGNMENT OF REAR BURNER CERAMIC TARGET AND DEFLECTOR ASSEMBLY - Every 4 to 6 Months.

1. Using a flashlight and an inspection mirror, check for a 1 inch (25mm) space between the top center edge of the rear ceramic target and the back wall of the frypot.

2. To get the 1 inch (25mm) space, the ceramic target bracket can be bent away from or toward the rear wall of the frypot.

NOTE: Access to the rear target bracket may be obtained through the lower opening at the rear of the fryer cabinet.

3. Check for a 3/4 inch (19.05mm) space between the top edge of the side targets and the wall of the frypot.

4. To get the 3/4 inch (19.05mm) space, the side target brackets can be bent away from or toward the wall of the frypot.

CLEAN THE GAS VALVE VENT TUBE - Every 6 Months.

1. Using a small adjustable wrench, unscrew the tube and fitting from the gas valve.

2. The vent tube can be straightened by hand.

3. Insert a piece of wire in the tube to remove any grease, dirt, or lint.

4. After removing the wire, blow through the tube to make sure the tube is clear of debris.

5. Re-install the tube on the gas valve. Carefully bend the tube so that the open end is pointing toward the floor and back of fryer.

8. J1C/MJ15 SERIES COMPONENTS

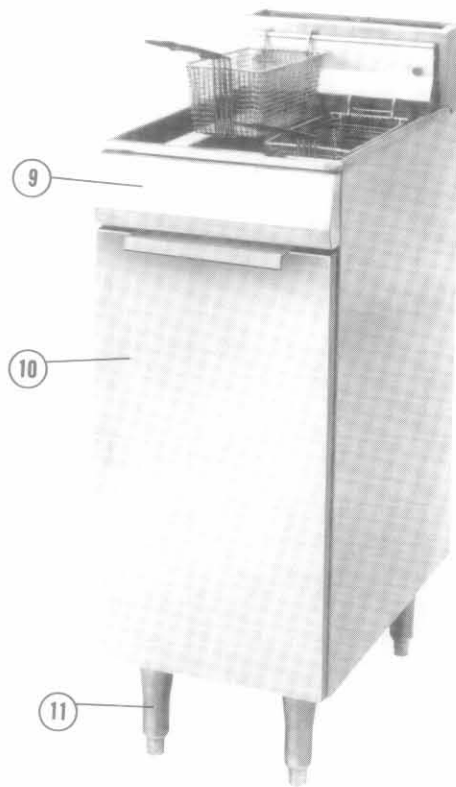
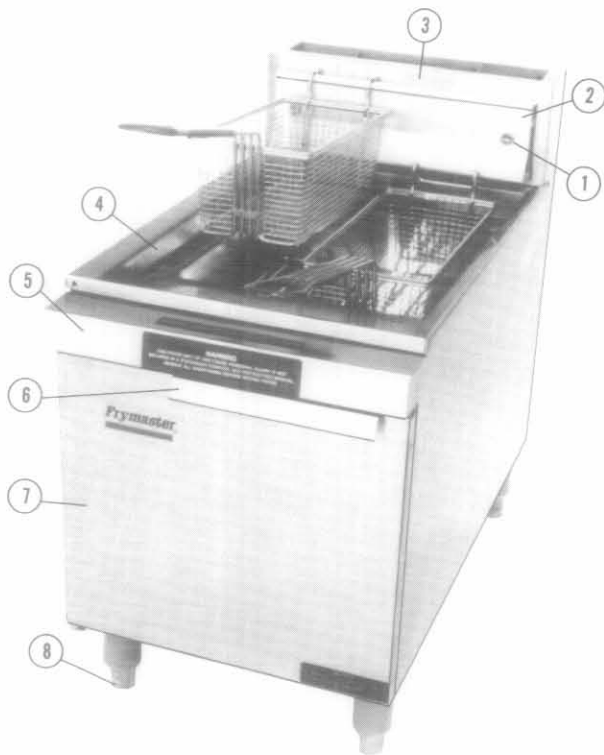

ITEM	PART #	DESCRIPTION	ITEM	PART #	DESCRIPTION
1	809-0171	Basket Hanger Screw (2) J1C/MJ15	7	806-0280	Door, Painted, J1C
2	803-0028	Basket Hanger, J1C/MJ15	7	823-0181-1	Stainless Door, J1C
3	910-4569	Flue Cap, J1C/MJ15	8	803-0053	Adjustable Leg, J1C
4	806-1949	Frypot Assembly, CR, J1C/MJ15	9	823-0174	Cowl, MJ15
4	806-1949-1	Frypot Assembly, SS, J1C/MJ15	10	806-1338	Door, Painted, MJ15
5	823-0164	Cowl, J1C	10	806-1338-1	Stainless Door, MJ15
6	810-0180	Door Handle, J1C/MJ15	11	806-3811	Adjustable Leg Set (4), MJ15

9. BURNER COMPONENTS

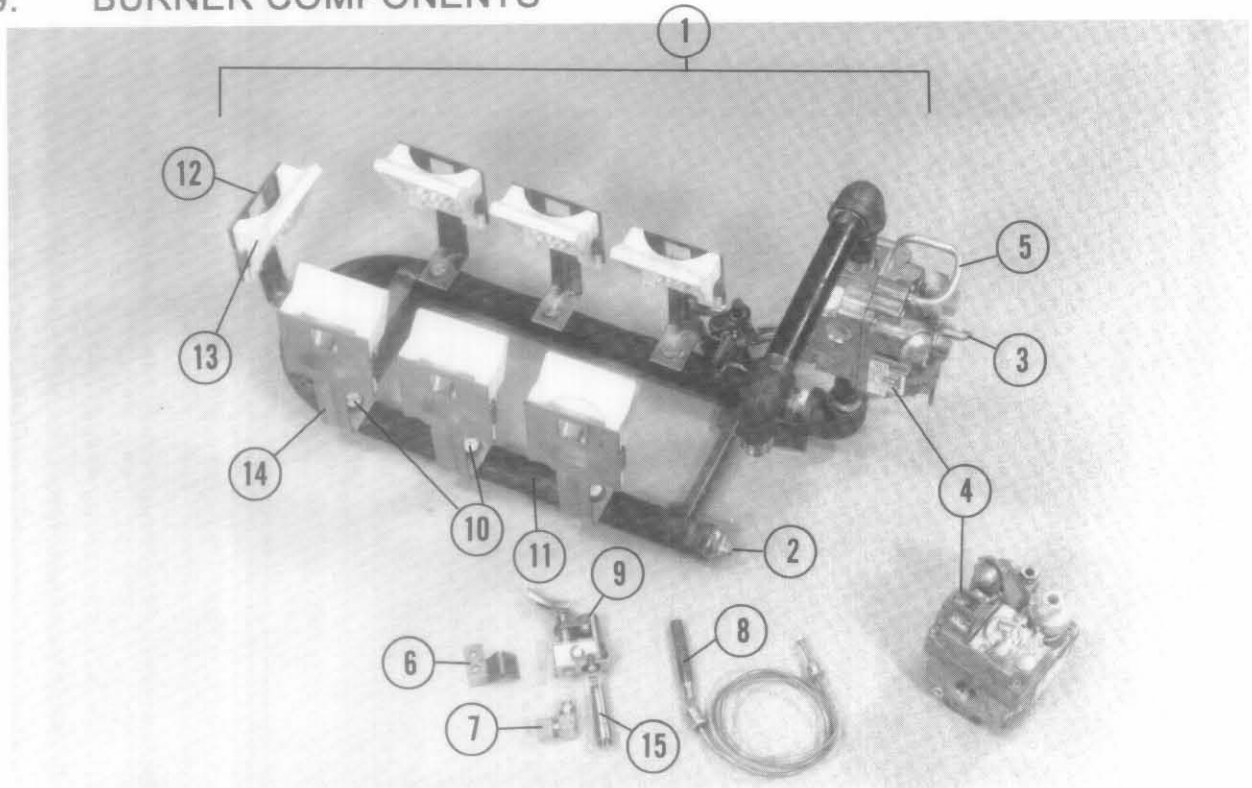

ITEM	PART #	DESCRIPTION
1	806-0507	Burner and Control Assembly, Natural Gas
1	806-1117	Burner and Control Assembly, LP Gas
2	813-0154	Pressure Test Port Plug
3	810-0691	Vent Tube
4	807-0115	Unitrol Gas Valve, Natural Gas, Before Series AG
4	807-0755	Unitrol Gas Valve, LP Gas, Before Series AG
*	810-0109	Gas Valve Knob, Before Series AG
*	810-0975	Gas Valve Knob, Series AG and After
5	810-0702	Pilot Tubing, Gas Valve to Pilot
6	900-1033	Pilot Mounting Bracket
*	809-0092	Screw, Pilot Burner Mounting
*	810-0234	Manual Gas Shut-Off Valve
7	810-0149	Pilot Orifice, Natural Gas
7	810-0148	Pilot Orifice, LP Gas
8	810-0612	Pilot Generator (Thermopile), Before Series AG with Unitrol Valve
8	810-0617-1	Pilot Generator (Thermopile), Series AG and After with Honeywell Valve
9	810-0426	Pilot Burner, ITT 262A38, Natural Gas
9	810-0427	Pilot Burner, ITT 262A38, LP Gas
9	810-0615	Pilot Burner, ITT 262A38 Natural with Pilot Generator, Before Series AG
9	810-0616	Pilot Burner, ITT 262A38 LP Gas with Pilot Generator, Before Series AG
10	810--0131	Burner Orifice, Natural Gas, 1.30mm
10	810-0140	Burner Orifice, LP Gas, .81mm
*	900-1033	Screw, Pilot Mounting Bracket to Manifold
11	823-0244	Burner Manifold ONLY
12	806-4720	Deflector Assembly
13	814-0034	Ceramic Target
14	910-1465	Deflector Bracket
*	809-0170	Burner Mounting Screw
15	810-0425	Adaptor Sleeve for Pilot Generator Cartridge

* Not Illustrated

10. ACCESSORIES

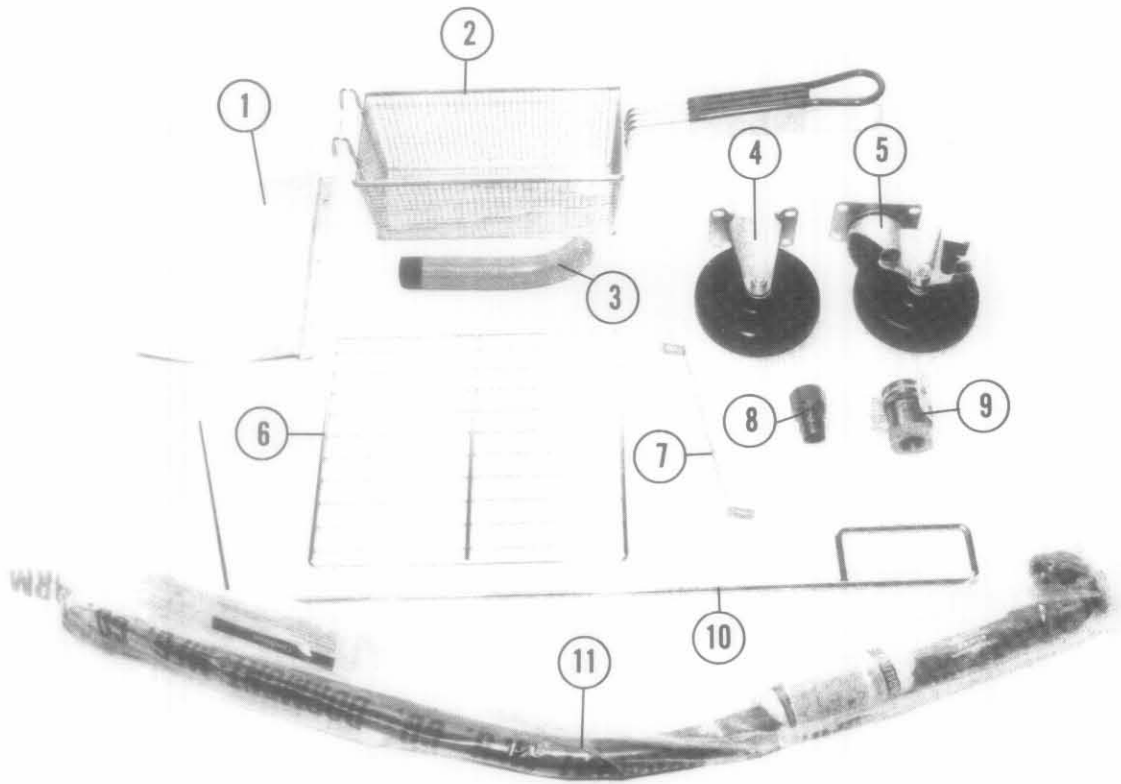

ITEM	PART NO.	DESCRIPTION	ITEM	PART NO.	DESCRIPTION
1	910-3207	Flue Deflector, Optional, J1C/MJ15	7	900-1835	Anchor Strap (2), MJ15
2	803-0019	Twin Size Basket (2), J1C/MJ15	8	810-0071	Quick Disconnect ½" Male, J1C/MJ15 (opt.)
3	813-0276	Drain Nipple, J1C/MJ15	9	810-0069	Quick Disconnect ½" Female, J1C/MJ15 (opt.)
4	810-0378	Rigid Caster w/o Brake, MJ15 (opt.)	10	803-0047	Frypot Cleanout Rod, J1C/MJ15 (opt.)
5	810-0357	Swivel Caster w/Brake, MJ15 (opt.)	11	810-0081	Flex. Gas Line ½" x 36", J1C/MJ15 (opt.)
6	803-0030	Basket Support Rack, J1C/MJ15	*	810-0082	Flex. Gas Line ½" x 48", J1C/MJ15 (opt.)

* - Not shown

11. THERMOSTAT COMPONENTS

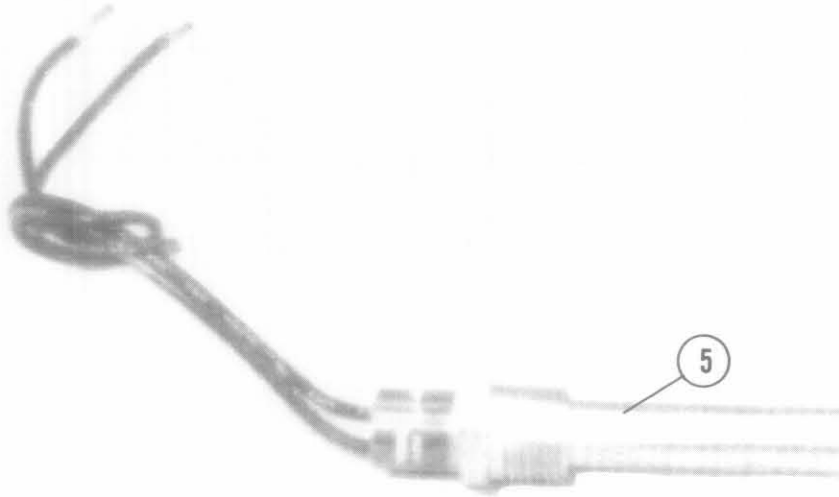
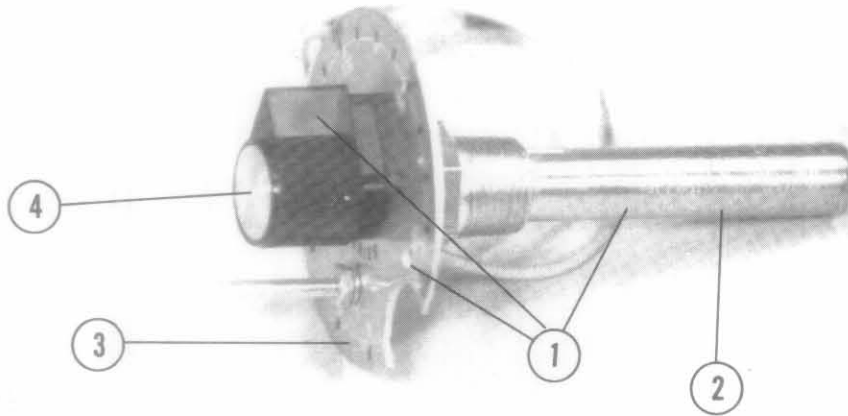

ITEM	PART #	DESCRIPTION
1	806-0138	Thermostat Assembly Kit
2	806-0184	Thermostat Assembly
3	806-0087	Thermostat Dial Plate Assembly
4	810-0110	Thermostat Knob
5	806-0814	Hi-Limit Thermostat

12. FRYPOT COMPONENTS

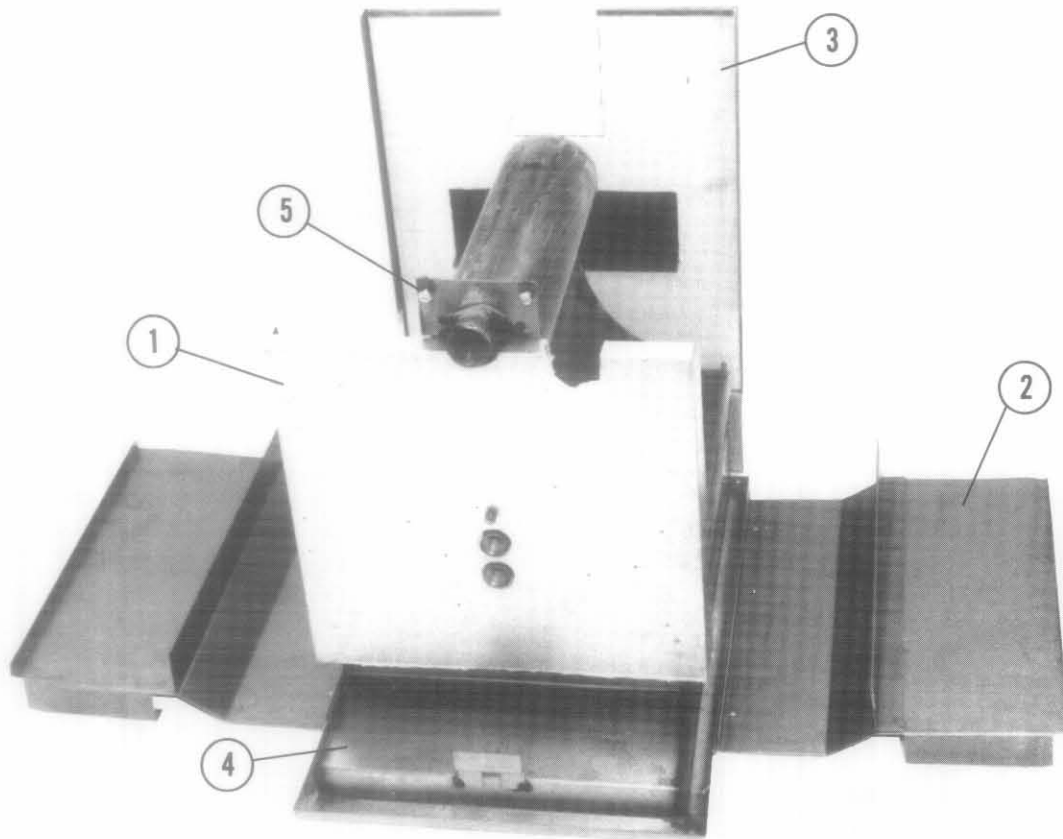

ITEM	PART #	UNIT	DESCRIPTION
1	806-0283	J1C/MJ15	Baffle Pot Front Assembly
2	806-0496	J1C/MJ15	Baffle Pot Side Assembly
3	806-0277	J1C/MJ15	Flue Assembly
*	810-4146	J1C/MJ15	Drain Valve 1 in.
4	823-1675	J1C/MJ15	Frypot Only, CR
4	823-1675-1	J1C/MJ15	Frypot Only, SS
5	809-0173	J1C/MJ15	Clip Nut for Mounting Burner to Frypot

* Not Illustrated

13. FRYER TROUBLESHOOTING GUIDE

NOTE: This guide does not include every possible problem and cause. Careful observation of all malfunction indications and logical troubleshooting will help in correcting the problem quicker. See SERVICE PROCEDURES to replace fryer components.

PROBLEM	PROBABLE CAUSE	CORRECTIVE ACTION
THERMOSTAT DOES NOT CALL FOR HEAT (DOES NOT ENERGIZE GAS CONTROL VALVE AT ALL).	A. Thermostat wires damaged or broken.	A. Repair or replace thermostat wires.
	B. Thermostat set too low.	B. Increase thermostat setting.
	C. Thermostat out of calibration.	C. Recalibrate. See "Service Procedures".
	D. Thermostat contacts burned and pitted.	D. Replace thermostat.
THERMOSTAT DOES NOT CONTROL AT SET POINT.	A. Thermostat out of calibration.	A. Recalibrate thermostat. See "Service Procedures".
	B. Contaminated thermostat contacts.	B. Replace thermostat.
PILOT OUTAGE	A. Automatic gas valve knob turned to OFF position.	A. Turn gas valve to pilot position, relight pilot.
	B. Low pilot flame.	B. Adjust pilot flame to 1½ in. (38.1mm).
	C. Clogged pilot orifice.	C. Remove, clean pilot orifice. Reinstall.
	D. Pilot burner clogged around pilot generator.	D. Remove pilot burner. Clean burner.
	E. Pilot flame blowing away from pilot generator (excessive draft in kitchen).	E. Eliminate draft in kitchen.
	F. Pilot generator not inserted fully into pilot burner.	F. Reinsert pilot generator into pilot burner until flame surrounds tip.
	G. Pilot generator low output.	G. Replace pilot generator.
	H. High resistance in hi-limit thermostat contacts.	H. Replace hi-limit thermostat.
	I. Defective pilot magnet in gas valve.	I. Replace gas valve.
	J. Corroded connection where pilot generator connects to gas valve.	J. Clean pilot generator connection at gas valve.

PROBLEM	PROBABLE CAUSE	CORRECTIVE ACTION
MAIN BURNER WILL NOT COME ON. PILOT REMAINS LIT.	A. Loose, dirty or corroded terminals on gas valve.	A. Clean and tighten terminals on gas valve.
	B. Loose, dirty or corroded terminals on thermostat.	B. Clean and tighten terminals on thermostat.
	C. High resistance in contacts of thermostat.	C. Replace thermostat.
	D. Thermostat out of calibration.	D. Calibrate thermostat. See "Service Procedures".
	E. Automatic gas valve defective.	E. Replace automatic gas valve.
	F. Automatic gas valve knob turned to pilot position.	F. Turn gas valve knob to ON position.
MAIN BURNER DOES NOT LIGHT ALL THE WAY AROUND	A. Rear burner flame deflector broken off.	A. Install new rear burner flame deflector.
	B. Burner gas pressure too high or too low.	B. Adjust gas pressure. Natural - 4.0 in. W.C. (0.99kPa), LP - 10.0 in. W.C. (2.49kPa).
	C. One or more main burner orifices clogged.	C. Clean burner orifices and blow out with compressed air.
	D. Fryer flue connected directly to vent hood with a chimney-like duct.	D. Remove chimney-like duct and allow for at least 18 inches (45.7cm) between flue outlet and vent hood filters.
MAIN BURNER DELAYED IGNITION (WHEN DELAY IS ONLY 2 OR 3 SECONDS).	A. One or more burner flame deflectors broken off.	A. Install new burner flame deflectors.
	B. Pilot flame low -- less than 1 inch (25.4 mm).	B. Adjust pilot flame to 1½ in. (38.1mm).
	C. Pilot flame directed away from first orifice on main burner.	C. Reposition pilot hood to direct flame toward first burner orifice.
	D. Fryer incoming gas pressure too low.	D. Have local gas company raise incoming gas to the proper pressure.
	E. Fryer incoming gas line too small.	E. Replace incoming gas line with proper size.
	F. One or more burner orifices clogged.	F. Clean burner orifices with proper orifice drill.
FLAME ROLLING OUT UNDER FRYER	A. Flue obstructed.	A. Clean obstruction from flue.
	B. Too little make-up air in store.	B. Increase make-up air into store.
PILOT LIGHT REMAINS LIT WHEN GAS VALVE IS PUSHED IN, BUT GOES OUT WHEN RELEASED.	A. Gas valve pilot magnet weak.	A. Replace gas valve.
	B. Pilot generator has low millivolt output.	B. Replace pilot generator.
	C. Hi-limit thermostat stuck open.	C. Replace hi-limit thermostat.
	D. Loose, dirty or corroded hi-limit wires.	D. Clean/tighten hi-limit wires on gas valve.

14. SERVICE PROCEDURES

WARNING: Before performing any maintenance on your Frymaster fryer, you must disconnect the electrical power supply.

CAUTION: When installing thermostats, DO NOT OVER TORQUE.

When electrical wires are disconnected, it is recommended that they be marked to facilitate reassembly.

A. Replace Controlling or Hi-Limit Thermostat

- 1) Drain shortening from the frypot.
- 2) Use an Allen wrench to loosen set screw at the side of the thermostat knob. Remove the thermostat knob. See Figure 1.

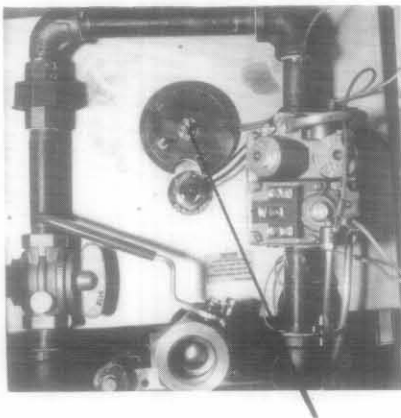

Fig. 1

- 3) Remove the 2 set screws on either side of the thermostat shaft and remove the dial plate.
- 4) Disconnect the thermostat wires from gas valve. See Figure 2.

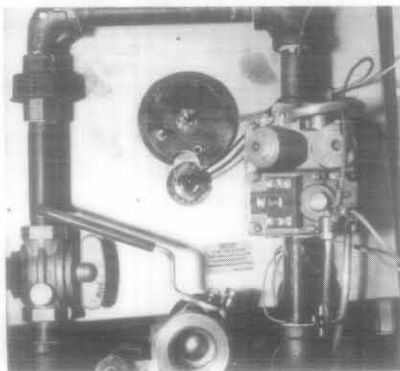

Fig. 2

- 5) Use a slotted socket to unscrew the thermostat from the frypot.

- 6) Apply a small amount of Loctite PST56765 compound to the threads of the new thermostat. Install the thermostat.
- 7) To change the hi-limit thermostat, disconnect the wires at the gas valve and follow instructions listed in Steps A.5) and A.6) to replace thermostat.

B. Calibrating Thermostat After Installation

- 1) Fill the frypot to the OIL-LEVEL LINE with shortening. Pre-melt solid shortening before starting calibration.
- 2) Ensure the gas valve knob is in the OFF position.
- 3) Insert a good grade mercury thermometer or pyrometer in the center of the frypot 2 to 3 inches (50 to 75mm) deep.
- 4) Turn the fryer gas valve to the ON position.

NOTE: If the burner does not light at this time, it does not mean the thermostat is defective. Recheck the wiring, then slowly turn the thermostat adjusting screw counterclockwise until the burner lights. Turning the adjusting screw counterclockwise causes the burner to light and clockwise causes it to shut off.

- 5) When the shortening temperature reaches 325° F (162°C), turn the thermostat adjusting screw clockwise until the burner shuts off.
- 6) Allow the fryer to set for a few minutes, then slowly turn the thermostat adjusting screw counterclockwise until the burner lights.
- 7) Repeat Steps B.5) and B.6) until 325° F (162°C) is reached. A good calibration point is halfway between the lowest and highest temperature dial readings. That reading being at the 12 o'clock position. The fryer is in calibration if the burner lights at the calibration point as the shortening temperature drops - not when the burner shuts off as the temperature rises.
- 8) Once the calibration point of 325° F (162°C) is reached, the burner should be allowed to cycle on and off at least 3 times to be sure it will light at the calibrated temperature.
- 9) After the thermostat calibration is complete, turn off the fryer.
- 10) Reinstall the knob on the thermostat shaft making sure the pointer on the knob points to the 325° position.

C. Replace the Pilot Generator Cartridge

- 1) Disconnect pilot generator wires from the top of the gas valve. See Figure 3.

- 2) Pull out on the retaining clip holding cartridge. See Figure 4.

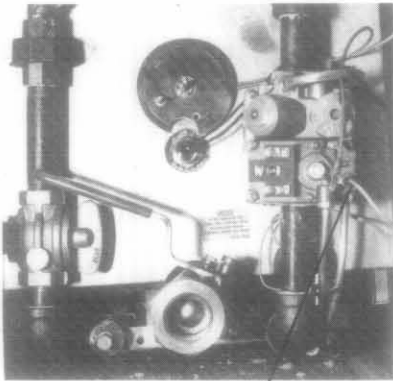

Fig. 3

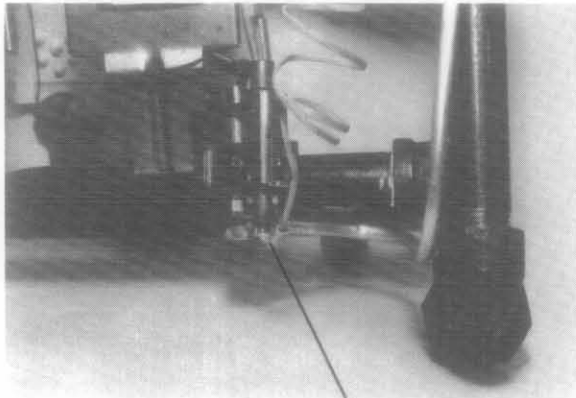

Fig. 4

- 3) Push down on cartridge and remove from the pilot assembly.
- 4) Reverse the previous procedures to install the new cartridge.

D. Adjust pilot flame

- 1) Remove the screw from the pilot adjustment hole on the gas valve. See Figure 5.

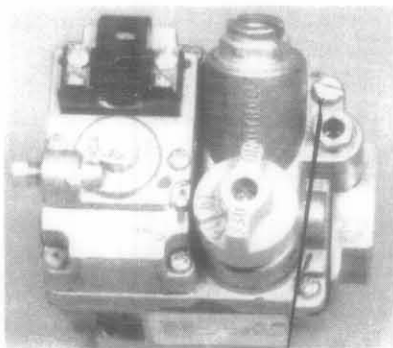

Fig. 5

- 2) Use a small tip screwdriver to turn the pilot adjusting screw counterclockwise to obtain a pilot flame of 1 to 1½ in. long. To decrease

the length of the pilot flame, turn the screw clockwise.

- 3) Reinstall the pilot adjustment hole cap when the required flame size is obtained.

E. Burner Gas Pressure Adjustment

- 1) Obtain a good quality water manometer or water column pressure gauge.
- 2) Turn the gas valve knob to the pilot position.
- 3) Remove the pressure tap plug from the end of the burner manifold. See Figure 6.

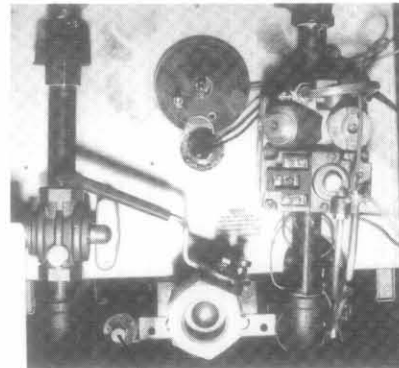

Fig. 6

- 4) Install fitting furnished with the manometer or pressure gauge into the burner manifold pressure tap plug hole and attach manometer hose to fitting.
- 5) Remove the cap from the gas valve regulator adjustment screw. Turn the gas valve to the ON position. See Figure 7.
- 6) Increase the setting on the thermostat until the burner comes on.

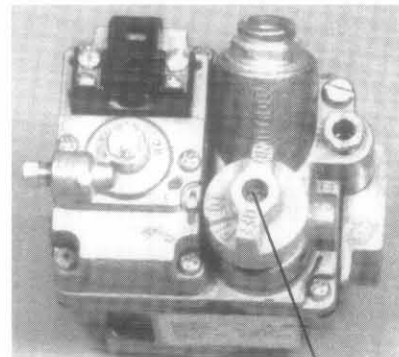

Fig. 7

- 7) Monitor the gas pressure reading on the manometer or pressure gauge.
- 8) Adjust the gas valve regulator adjustment screw to obtain burner manifold pressure as follows:

Natural Gas - 4 in. W.C. (1.0 kPa).
LP Gas - 10.0 in. W.C. (2.50 kPa).

Turning the screw clockwise increases pressure, counterclockwise decreases pressure.

- 9) Install the gas valve regulator cap screw when the correct manifold pressure is obtained.
- 10) Switch fryer off, remove the manometer fitting from the manifold tap hole, and reinstall the pressure tap plug.

F. Replacing the Fryer Gas Valve

- 1) Disconnect the gas supply to the fryer.
- 2) Disconnect the wires from the gas valve terminal block. Mark wires to facilitate reinstallation.
- 3) Remove the pilot gas line and fitting from the valve. See Figure 8.

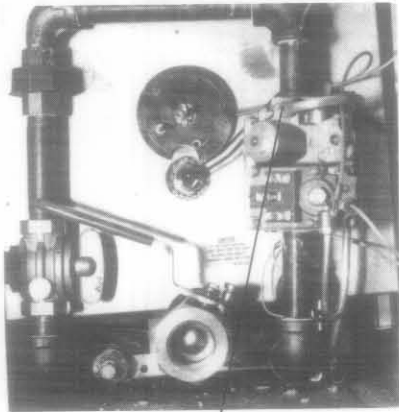

Fig. 8

- 4) Loosen pipe union on the side of the valve and remove the valve.
- 5) Remove the pipe fittings from the old gas valve and install on the replacement valve. Apply PST56765 Loctite pipe thread sealant to threads.
- 6) Reverse the previous procedures to install replacement gas valve.

G. Removing the Main Burner Assembly

- 1) Disconnect the gas supply to the fryer.
- 2) Disconnect the control and hi-limit wires at the gas valve.
- 3) Loosen the pipe union to the left of the valve. See Figure 9.

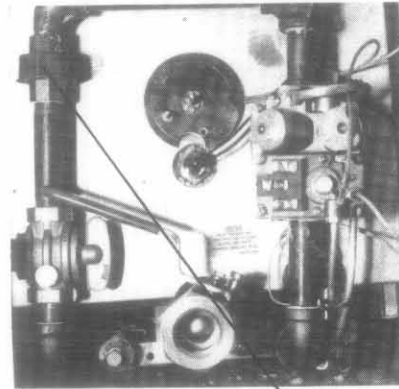

Fig. 9

- 4) Remove the 2 burner hanger screws. See Figure 10.

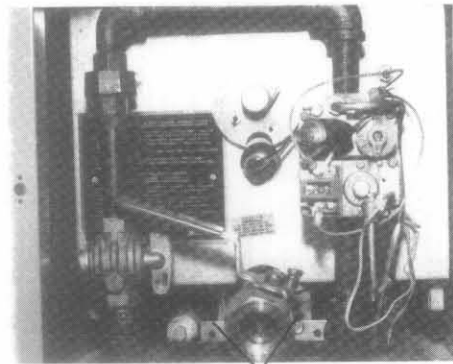

Fig. 10

- 5) Lower the front of the burner assembly and pull straight out to remove.
- 6) Reverse the previous procedures to re-install burner assembly.

H. Replacing Burner Ceramic Target

- 1) Disconnect the gas supply to the fryer.
- 2) See Step G. (Removing Main Burner Assembly).
- 3) Unlock the ceramic target locking tab with needle nose pliers or screwdriver, slide the ceramic target up off the deflector. See Figure 11.

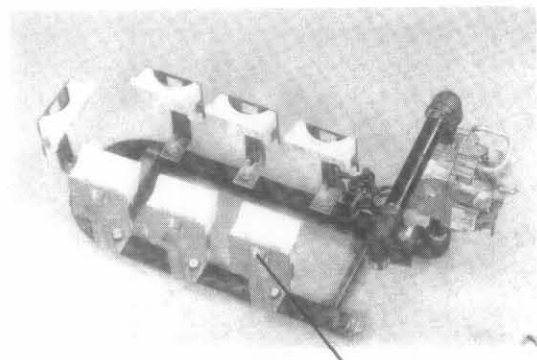

Fig. 11

- Reverse the previous procedures to install the new ceramic target.

I. Replacing Burner Ceramic Target and Deflector

- Disconnect the gas supply to the fryer.
- See Step G. (Removing Main Burner Assembly).
- Using a 1/2 in. box end wrench or socket and ratchet, remove the 2 brass orifices that hold the target bracket to the burner manifold. See Figure 12.

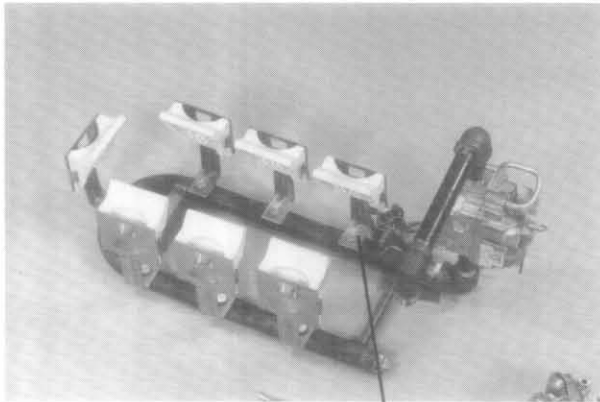

Fig. 12

- Reverse the previous procedures to install the replacement ceramic target and deflector.

CAUTION: Use caution to prevent cross threading and stripping when reinstalling the brass orifices.

J. Alignment & Adjustment of Burner Ceramic Target and Deflector Assemblies

- Proper alignment of all burner targets should be 3/4 in. between the top edge of the ceramic targets and the wall of the frypot. See Figure 13

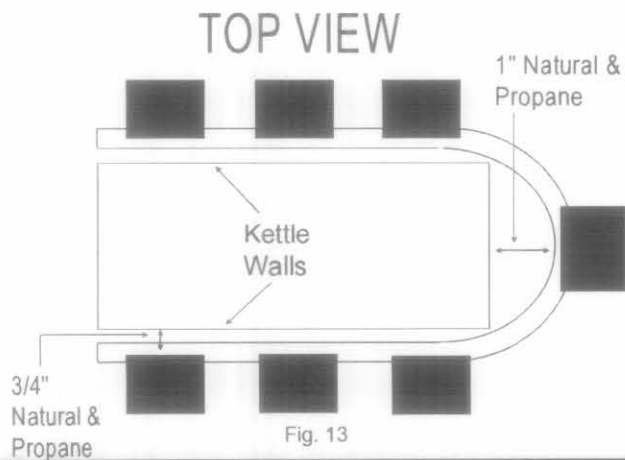

Fig. 13

- To adjust targets, bend the deflector brackets away or toward the frypot to obtain the 3/4 in. measurement.

K. Replacing the Frypot

- Drain all shortening from the frypot.
- Disconnect the fryer from the gas supply.
- If equipped, remove the frypot covers and basket hangers.
- Remove the screws from the cowl and lift up and off the fryer. See Figures 14 and 15.



Fig. 14

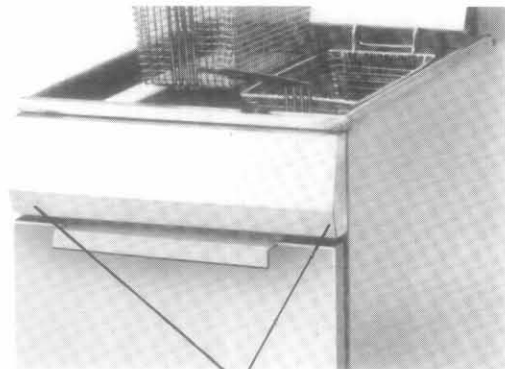

Fig. 15

- Remove the screws from the sides and back of the flue cap and remove the flue cap. See Figure 16.

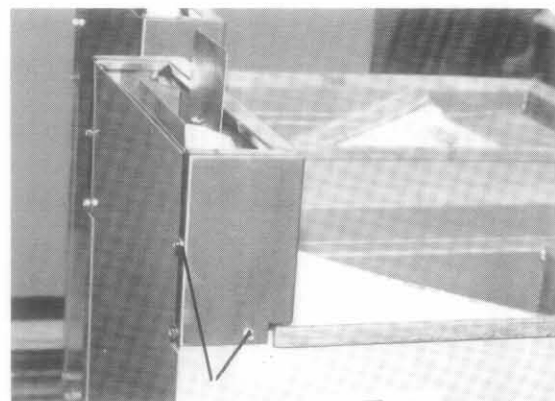

Fig. 16

-
- 6) Lift frypot complete with burner, gas valve, flue, drain valve, and combustion chamber from the fryer cabinet. After lifting frypot partially out of the cabinet, tilt the front of the pot up slightly to clear the drain valve.
 - 7) Remove the burner assembly, flue, drain valve and combustion chamber from the old frypot and install on the new frypot.
 - 8) Reverse the previous procedures to install the new frypot assembly.

15. WIRING DIAGRAMS

CONTROL CIRCUIT FOR
ROBERTSHAW-7000 BMVR GAS VALVE

