



**YSCF14G / YFPH1814G**  
**Series Gas Fryers**  
**Installation & Operation Manual**

***Frymaster***<sup>®</sup>



Frymaster and Dean, members of the Commercial Food Equipment Service Association, recommend using CFESA Certified Technicians.

[www.frymaster.com](http://www.frymaster.com)

**24-Hour Service Hotline**

**1-800-551-8633**

**06/2023**



8 1 9 6 1 3 2

**Please read all sections of this manual and retain for future reference.**

**NOTICE**

This appliance is intended for professional use only and is to be operated by qualified personnel only. A Frymaster Dean Factory Authorized Servicer (FAS) or other qualified professional should perform installation, maintenance, and repairs. Installation, maintenance, or repairs by unqualified personnel may void the manufacturer's warranty.

**NOTICE**

This equipment must be installed in accordance with the appropriate national and local codes of the country and/or region in which the appliance is installed.

**NOTICE**

Drawings and photos used in this manual are intended to illustrate operational, cleaning and technical procedures and may not conform to onsite management operational procedures.

**NOTICE TO OWNERS OF UNITS EQUIPPED WITH COMPUTERS**

**U.S.**

This device complies with Part 15 of the FCC rules. Operation is subject to the following two conditions: 1) This device may not cause harmful interference, and 2) This device must accept any interference received, including interference that may cause undesired operation. While this device is a verified Class A device, it has been shown to meet Class B limits.

**CANADA**

This digital apparatus does not exceed the Class A or B limits for radio noise emissions as set out by the ICES-003 standard of the Canadian Department of Communications.

Cet appareil numérique n'émet pas de bruits radioélectriques dépassant les limites de classe A et B prescrites dans la norme NMB-003 édictée par le Ministre des Communications du Canada.

** DANGER**

Improper installation, adjustment, maintenance or service, and unauthorized alterations or modifications can cause property damage, injury, or death. Read the installation, operating and service instructions thoroughly before installing or servicing this equipment. Only qualified service personnel may convert this appliance to use a gas other than that for which it was originally configured.

**NOTICE**

The Commonwealth of Massachusetts requires any and all gas products to be installed by a licensed plumber or pipe fitter.

**⚠ DANGER**

Adequate means must be provided to limit the movement of this appliance without depending upon the gas line connection. Single fryers equipped with legs must be stabilized by installing anchor straps. All fryers equipped with casters must be stabilized by installing restraining chains. If a flexible gas line is used, an additional restraining cable must be connected at all times when the fryer is in use.

**⚠ DANGER**

The front ledge of the fryer is not a step. Do not stand on the fryer. Serious injury can result from slips or contact with the hot oil.

**⚠ DANGER**

Do not store or use gasoline or other flammable vapors and liquids in the vicinity of this or any other appliance.

**⚠ DANGER**

Instructions to be followed in the event the operator smells gas or otherwise detects a gas leak must be posted in a prominent location. This information can be obtained from the local gas company or gas supplier.

**NOTICE**

IF, DURING THE WARRANTY PERIOD, THE CUSTOMER USES A PART FOR THIS FRYMASTER DEAN EQUIPMENT OTHER THAN AN UNMODIFIED NEW OR RECYCLED PART PURCHASED DIRECTLY FROM FRYMASTER DEAN, OR ANY OF ITS AUTHORIZED SERVICERS, AND/OR THE PART BEING USED IS MODIFIED FROM ITS ORIGINAL CONFIGURATION, THIS WARRANTY WILL BE VOID. FURTHER, FRYMASTER DEAN AND ITS AFFILIATES WILL NOT BE LIABLE FOR ANY CLAIMS, DAMAGES OR EXPENSES INCURRED BY THE CUSTOMER WHICH ARISE DIRECTLY OR INDIRECTLY, IN WHOLE OR IN PART, DUE TO THE INSTALLATION OF ANY MODIFIED PART AND/OR PART RECEIVED FROM AN UNAUTHORIZED SERVICER.

**⚠ DANGER**

The crumb tray in fryers equipped with a filter system must be emptied into a fireproof container at the end of frying operations each day. Some food particles can spontaneously combust if left soaking in certain shortening material.

**⚠ WARNING**

No structural material on the fryer should be altered or removed to accommodate placement of the fryer under a hood. Questions? Call the Frymaster Dean Service Hotline at 1-800-551-8633.

**⚠ WARNING**

Do not bang fry baskets or other utensils on the fryer's joiner strip. The strip is present to seal the joint between the frypot. Banging fry baskets on the strip to dislodge shortening will distort the strip, adversely affecting its fit. It is designed for a tight fit and should only be removed for cleaning.

# YSCF14G/YFPH1814G

## INSTALLATION & OPERATION MANUAL

### TABLE OF CONTENTS

	Page #
1. Installation .....	1-1
2. Fryer Operations .....	2-1
3. Filtration Instructions .....	3-1
4. Computer Operation .....	4-1
5. Preventive Maintenance .....	5-1

# YSCF14G- YFPH1814G SERIES GAS FRYERS

## CHAPTER 1: INSTALLATION

### 1.1 Gas Connections

** DANGER**

**Before connecting new pipe to this appliance the pipe must be blown out thoroughly to remove all foreign material. Foreign material in the burner and gas controls will cause improper and dangerous operation.**

#### NATIONAL CODE REQUIREMENTS

This equipment is to be installed in compliance with the Basic Plumbing Code of the Building Officials and Code Administrators International, Inc. (BOCA) and the Food Service Sanitation Manual of the U.S. Food and Drug Administration.

This equipment is manufactured to use the type of gas specified on the rating plate attached to the door. Connect equipment stamped "NAT" only to natural gas and that stamped "PRO" only to LP (Propane) gas.

**Installation shall be made with a gas connector that complies with national and local codes. Quick disconnect devices, if used, shall likewise comply with national and local codes.**

** DANGER**

**The fryer MUST be connected to the gas supply specified on the rating and serial number plate located on the back of the fryer door.**

** DANGER**

**If gas odors are detected, the gas supply MUST be shut off at the main shut-off valve. The local gas company or FASC should be contacted immediately to rectify the problem.**

- A. The gas supply (service) line must be the same size or greater than the fryer inlet line. This fryer is equipped with a 3/4" (22 mm) male inlet. The gas supply line must be sized to accommodate all the gas-fired equipment that may be connected to that gas supply. Consult your contractor, gas company, supplier, or other knowledgeable authorities.

<b>Recommended Gas Supply Line Sizes</b>			
<b>Gas Types</b>	<b>Number of Fryers</b>		
	1	2 to 3	4 or more (*)
Natural Gas	3/4" (22 mm)	1" (28 mm)	1-1/4" (35 mm)
Propane Gas	1/2" (15 mm)	3/4" (22 mm)	1" (28 mm)
(*) When exceeding 18 feet (6 meters) for a configuration of more than four fryers, it is necessary to provide a 1 1/4" (33 mm) rigid gas connection.			

YSCF14G- YFPH1814G SERIES GAS FRYERS  
CHAPTER 1: INSTALLATION

---

## 1.1 Gas Connections (cont.)

 **DANGER**

All connections must be sealed with a joint compound suitable for the gas being used and all connections must be tested with a solution of soapy water before lighting any pilots.

Never use matches, candles, or any other ignition source to check for leaks. If gas odors are detected, shut off the gas supply to the appliance at the main shut-off valve and immediately contact the local gas company or an authorized service agency for service.

 **DANGER**

"Dry-firing" your unit will cause damage to the frypot and can cause a fire. Always ensure that melted shortening, cooking oil or water is in the frypot before firing the unit.

- B. Rigid Connections: Check any installer-supplied intake pipe(s) and clean threading chips, or any other foreign matter before installing into a service line. If the intake pipes are not clear of all foreign matter, the orifices will clog when gas pressure is applied. Seal pipe joints with a sealant resistive to LP gas. When using thread compound on gas piping, use very small amounts and only on male threads. Use a pipe thread compound that is not affected by the chemical action of LP gases. DO NOT apply thread compound to the first two pipe threads—doing so will cause clogging of the burner orifices and control valve.
- C. Manual shut-off valve: This gas service supplier-installed valve must be installed in the gas service line ahead of the fryers in the gas stream and in a position where it can be reached quickly in the event of an emergency.
- D. Regulating Gas Pressure: The fryer and shut-off valve must be disconnected from the gas supply during any pressure testing of the system.
  - 1. External gas regulators are not normally required on this fryer. A safety control valve protects the fryer against pressure fluctuations. If the incoming pressure is in excess of ½ PSI (3.45 kPa/35 mbar), **a step-down regulator will be required.**

 **DANGER**

When pressure-testing incoming gas supply lines, disconnect the fryer from the gas line if the test pressure is ½ PSI [3.45 kPa (14 inches W.C.)] or greater to avoid damage to the fryer's gas piping and gas valve(s).

**YSCF14G- YFPH1814G SERIES GAS FRYERS**  
**CHAPTER 1: INSTALLATION**

---

## **1.1 Gas Connections (cont.)**

- E. Manifold Pressure: Only qualified personnel should check the manifold pressure with a manometer.
1. Check the rating plate for manifold gas pressures. Natural gas units normally require 4" W.C., and propane units normally require 11" W.C. gas pressure.
  2. Double check the arrow forged into the bottom of the regulator body, which indicates gas flow direction. It should point downstream towards the fryers. The air vent cap is also part of the regulator and should not be removed.
  3. If a vent line from the gas pressure regulator is used, it should be installed in accordance with local codes or in the absence of local codes, with the National Fuel Gas Code, ANSI Z223.1-(latest edition).

 **WARNING**

**Use a diluted soap solution to find potentially dangerous gas leaks when making new connections.**

- F. Regulators can be adjusted in the field, but it is recommended that they not be tampered with unless the part is known to be out of adjustment or serious pressure fluctuations are found to exist and can be solved no other way.
- G. Only qualified service personnel should make adjustments to the regulators.
- H. Orifices: The fryer can be configured to operate on any available gas. The correct safety control valve, appropriate gas orifices, and pilot burner are installed at the factory. While the valve can be adjusted in the field, only qualified service personnel should make any adjustments with the proper test equipment.
- I. Flexible Couplings, Connectors and Casters:
1. If the fryer is to be installed with flexible couplings and/or quick-disconnect fittings, the installer must use a heavy-duty AGA design-certified commercial flexible connector of at least 3/4" NPT (with suitable strain reliefs), in compliance with the Standard for Connectors for Movable Gas Appliances, ANSI Z21.69-(latest edition) and Addenda Z21.69a-(latest edition). Quick disconnect devices must comply with the Standard for Quick-Disconnect Devices for Use with Gas Fuel, ANSI Z21.41-(latest edition).

 **WARNING**

**Do not attach accessories to this fryer unless fryer is secured from tipping. Personal injury may result.**

2. The fryer must be restrained by means independent of the flexible coupling or connector in order to limit the movement of the fryer. Clips are located on the back panel of the fryer for the attachment of restraints.

**YSCF14G- YFPH1814G SERIES GAS FRYERS**  
**CHAPTER 1: INSTALLATION**

---

## **1.1 Gas Connections (cont.)**

3. If disconnection of the restraint is necessary, this restraint must be reconnected after the fryer has been returned to its originally installed position.
- J. After hook-up, bleed the gas line of air to ensure that the pilot light will ignite quickly.
- K. CE Standards: If the unit is to be installed with flexible coupling, use a commercial flexible coupling certified as NF D 36123 (or other national standard) or a quick disconnect device certified NF D 36124 (or other national standard).

## **1.2 Electrical Connections**

The fryer when installed must be electrically grounded in accordance with local codes, or in the absence of local codes, with the National Electrical Code, ANSI/NFPA 70-(latest edition).

 **DANGER**

**This fryer is equipped with a three-prong (grounding) plug for protection against electrical shock and must be plugged directly into a properly grounded, three-prong receptacle. DO NOT CUT, REMOVE, OR OTHERWISE BYPASS THE GROUNDING PRONG ON THIS PLUG!**

The rating plate and wiring diagram are located inside the front door. The fryer is equipped with a 120VAC single-phase 60-hertz system (Domestic), or 230VAC single-phase 50-hertz system (International/CE). Do not cut or remove the ground prong from the power cord plug. Do not attempt to use the fryer during a power outage.

 **DANGER**

**This appliance requires electrical power for operation. Place the gas control valve in the OFF position in case of a prolonged power outage. Do not attempt to operate this appliance during a power outage.**



# YSCF14G- YFPH1814G SERIES GAS FRYERS

## CHAPTER 2: FRYER OPERATIONS

---

### 2.1 Unpacking Equipment

- A. Check that the container is upright. Use an outward prying motion - *no hammering* - to remove the carton. Unpack the fryer carefully and remove all accessories from the carton. Do not discard or misplace these, as they will be needed.
- B. After unpacking, immediately check the equipment for visible signs of shipping damage. If damage has occurred, contact the carrier and file the appropriate freight claims. Do not contact the factory. Shipping damage responsibility is between the carrier and the dealer.

#### **If your equipment arrives damaged:**

1. File claim for damages immediately, regardless of extent of damage.
2. Visible loss or damage: Be sure this is noted on the freight bill or express receipt and is signed by the person making the delivery.
3. Concealed loss or damage: If damage is unnoticed until equipment is unpacked, notify freight company or carrier immediately, and file a concealed damage claim. This should be done within 5 days of date of delivery. Be sure to retain container and all packing materials for inspection.

**NOTE: Dean Does Not Assume Responsibility for Damage or Loss Incurred in Transit.**

- C. **Frying systems with built-in filtration:** Take off the filter support brace and remove the filter pan from the cabinet.
- D. **Decathlon four-battery systems:** Casters are pre-installed on the frying system and the carton is furnished with three unloading ramps. Remove the braces from the front casters by taking out the securing bolts. Carefully roll the unit down the ramps from the front (cooking side).
- E. Remove all plastic skin from sides, front, and doors of the fryer(s). Failure to do this prior to initial fryer operation will make it very difficult to remove later.

YSCF14G- YFPH1814G SERIES GAS FRYERS  
CHAPTER 2: FRYER OPERATIONS

---

## 2.2 Initial Start-up

 **WARNING**

**The on-site supervisor is responsible for ensuring that operators are made aware of the inherent hazards of operating a hot oil frying system, particularly the aspects of system operation, oil filtration, draining and cleaning procedures.**

- A. Cleaning: New units are wiped clean with solvents at the factory to remove any visible signs of dirt, oil, grease, etc. remaining from the manufacturing process, then coated lightly with oil. Before any food preparation, wash thoroughly with hot, soapy water to remove any film residue and dust or debris then rinse out and wipe dry. Also wash any accessories shipped with the unit. Close the drain valve completely and remove the crumb screen covering the heating tubes. Ensure the screws holding the thermostat and high-limit control sensing bulbs into the frypot are tight.

 **WARNING**

**Do not bang fry baskets or other utensils on the fryer's joiner strip. The strip is present to seal the joint between the frypots. Banging fry baskets on the strip to dislodge shortening will distort the strip, adversely affecting its fit. It is designed for a tight fit and should only be removed for cleaning.**

 **DANGER**

**Never operate this appliance with an empty frypot. The frypot must be filled with water or cooking oil/shortening before lighting the burners. Failure to do so will damage the frypot and may cause a fire.**

 **WARNING**

**When checking for burner ignition or performance, do not get too close to the burners. Slow ignition can cause possible flashback, increasing the potential for facial and body burns.**

**YSCF14G- YFPH1814G SERIES GAS FRYERS**  
**CHAPTER 2: FRYER OPERATIONS**

---

### 2.3 Final Preparation

 **WARNING**

**Do not go near the area directly over the flue outlet while the fryer is operating.**

**Always wear oil-proof, insulated gloves when working with the fryer filled with hot oil.**

**Always drain hot oil into a metal container. Hot oil can melt plastic buckets and crack glass containers.**

 **WARNING**

**NEVER set a complete block of solid shortening on top of the heating tubes. To do so will damage the heating tubes and frypot, and void the warranty.**

- A. When using a liquid shortening (cooking oil), fill the fryer to ¼" below the top OIL LEVEL line scribed into the back of the frypot.
- B. When using a solid shortening, first melt it in a suitable container, or cut it into small pieces and pack it below the heat tubes, between the tubes and on top of the tubes, leaving no air spaces around the tubes. Do not disturb or bend the sensing bulbs. **Never set a complete block of solid shortening on top of the heating tubes. To do so will damage the heating tubes and frypot, and void the warranty.**
- C. Press the  switch to turn fryer on. The burners will initially operate in the MELT CYCLE mode until the shortening reaches 180°F (82°C). It will then automatically switch to normal operation.
- D. When the frypot is filled and the shortening is melted, carefully replace the frypot crumb screen over the heat tubes. Wear oil-proof insulated gloves to avoid the potential for burn injury when replacing crumb screen.
- E. Before starting operation, program the computer to the probable working temperature and wait for the temperature to stabilize.

**YSCF14G- YFPH1814G SERIES GAS FRYERS**  
**CHAPTER 3: BUILT-IN FILTRATION**

---

 **WARNING**

Drawings and photos used in this manual are intended to illustrate operational, cleaning and technical procedures and may not conform to on-site management operational procedures.

 **WARNING**

The on-site supervisor is responsible for ensuring that operators are made aware of the inherent hazards of operating a hot oil filtration system, particularly the aspects of oil filtration, draining and cleaning procedures.

 **WARNING**

When operating the filtration system, never leave the filter unattended. The action of the oil moving through the hose lines could jolt a flexible return hose (where applicable) out of the filter pan, spraying hot oil and causing severe burns.

 **DANGER**

The crumb tray in fryers equipped with a filter system must be emptied into a fireproof container at the end of frying operations each day. Some food particles can spontaneously combust if left soaking in certain shortening material.

**IMPORTANT**

Cooking oil/shortening should be filtered at least daily, or more frequently if cooking is heavy. This assures the longest life possible for the oil and minimizes flavor transfer.

# YSCF14G-YFPH1814G SERIES GAS FRYERS

## CHAPTER 3: BUILT-IN FILTRATION

### 3.1 General

Frymaster YSCF14G-YFPH1814G Series gas fryers come equipped with a built-in filtration system. Photos used in the procedural illustrations may differ slightly from the filter unit that came with the frying system. The following procedures apply to all YSCF14G-YFPH1814G Series gas fryers equipped with built-in filter systems.

### 3.2 Filtration Preparation

On initial installation and before each use, remove all loose parts from the filter, wash the filter pan and all accessories in hot, soapy water and dry thoroughly.

#### 3.2.1 Assembling the Filter

The YSCF14G-YFPH1814G Series UFF filter system uses a filter pad held in place by a hold-down ring to filter impurities and debris from the cooking oil. The filter pan is assembled with the following components (see illustration):

1. Filter pan.
2. Filter support grid.
3. Filter pad.
4. Hold-down ring.
5. Crumb screen.
6. Pan cover.

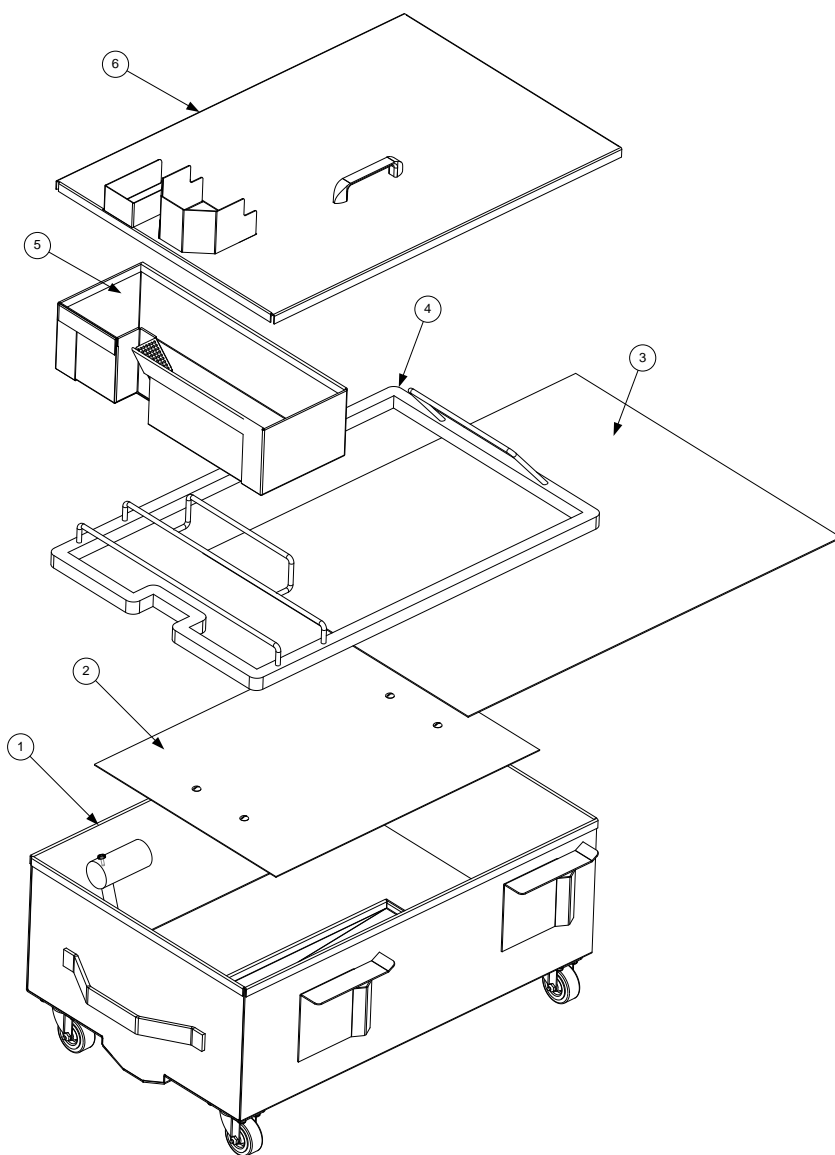

# YSCF14G- YFPH1814G SERIES GAS FRYERS

## CHAPTER 3: BUILT-IN FILTRATION

### 3.2.1 Assembling the Filter (cont.)

Assemble the filter as follows:

1. Place the support grid in the bottom of filter pan.
2. Center the filter pad in the filter pan with the notch toward the pick-up tube.
3. Position the hold-down ring on the filter pan with the notch toward the pick-up tube.
4. Place the crumb screen in the filter pan. Allow the crumb screen to rest on the top edges of the hold-down ring.

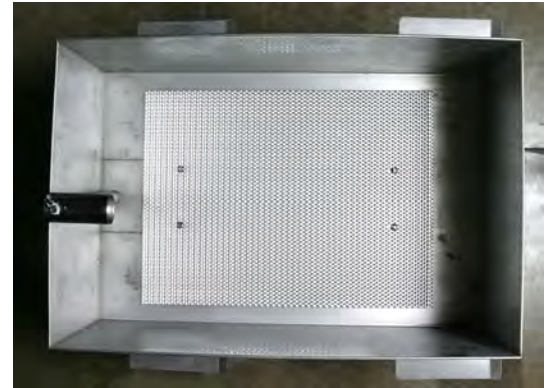

Support grid properly placed in filter pan.

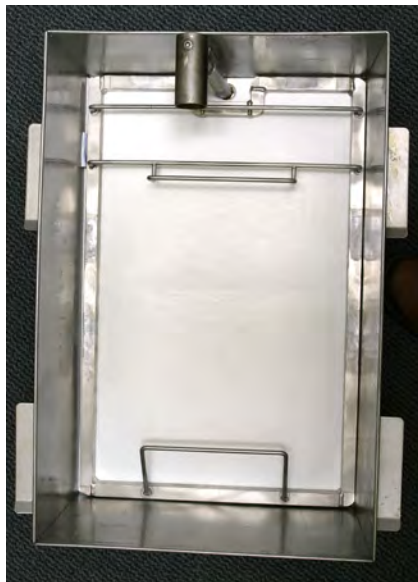

Hold-down ring shown over filter pad.



Filter pan shown with pad, hold-down ring and crumb tray in place.

5. Place filter pan cover onto the filter pan assembly. Ensure the front cover is correctly positioned over the slip fitting.

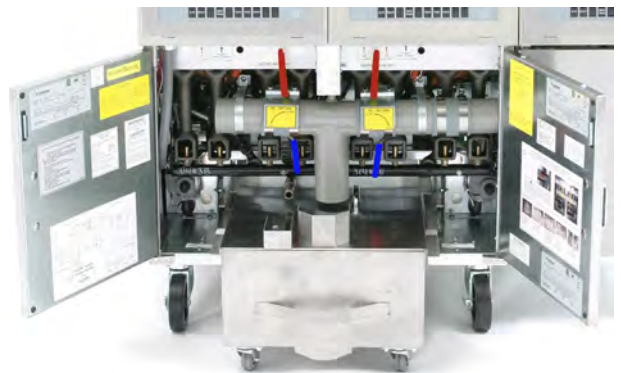

The filter pan is shown partially inserted under the fryer.

## YSCF14G- YFPH1814G SERIES GAS FRYERS

### CHAPTER 3: BUILT-IN FILTRATION

#### 3.2.2 Installing the Filter

Slide the filter inside the fryer cabinet. Ensure the male-female slip-fitting coupling is fully engaged.

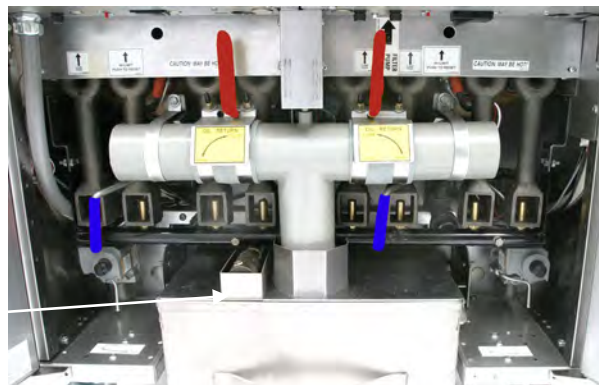

Ensure the filter pan is fully seated on the male connection (left, above) when it slides into place.

#### 3.3 Daily Filtration Operation

##### DANGER

Use caution and wear proper protective clothing. The oil to be filtered is at or near 350°F (177°C). Ensure all hoses are connected properly and drain handles are in their proper position prior to operating any switches or valves. Failure to do this can result in severe burns.

##### NOTICE

Drawings and photos used in this manual are intended to illustrate operational, cleaning and technical procedures and may not conform to on-site management operational procedures.

#### 3.3.1 General Overview

The filter pump is turned on only after the oil is brought to operating temperature and drained into the prepared filter pan. The filter motor is then engaged and oil is drawn through filter paper and pumped back into the frypot. The frypot's drain remains open during the filtering process. Allow the oil to cycle through the filter paper for approximately 30 minutes. At the end of 30 minutes, close the drain valve and allow the pump to fill the frypot to the top OIL LEVEL line. Leave the pump running for 10-15 seconds after bubbles appear in the frypot to ensure all oil is pumped from the drain pan and the lines.

## YSCF14G- YFPH1814G SERIES GAS FRYERS

### CHAPTER 3: BUILT-IN FILTRATION

---

#### 3.3.2 Filtering Tools

Assemble tools to be used for filtering. These are supplied with the filter starter kit included with the fryer/filter system:

- Frypot/Filter Brush - used to clean frypot and filter pan sides and bottom and to dislodge sediment during filtration or shortening/oil change.
- Clean-Out Rod (design may vary)- used to dislodge heavy debris in the drain tube (when needed).
- Filter Pad.

The following tools are not required, but are recommended to make the filtering task easier.

- Stainless Steel Crumb Scoop – for removing large debris from shortening/oil prior to filtering.

Note: Always wear oil-resistant, insulated gloves and/or protective gear when working with hot oil.

#### 3.4 Operating the Filter

 **DANGER**

**Draining and filtering of cooking oil or shortening must be accomplished with care to avoid the possibility of a serious burn caused by careless handling. The oil to be filtered is at or near 350°C (177°C). Ensure all hoses are connected properly and drain handles are in their proper position before operating any switches or valves. Wear all appropriate safety equipment when draining and filtering cooking oil or shortening.**

 **DANGER**

**Allow oil/shortening to cool to 100°F (38°C) before draining into an appropriate container for disposal.**



YSCF14G- YFPH1814G SERIES GAS FRYERS  
CHAPTER 3: BUILT-IN FILTRATION

---

### 3.4 Operating the Filter (cont.)

 **DANGER**

Do not drain more than one frypot at a time into the built-in filtration unit to avoid overflow and spillage of hot oil/shortening.

 **DANGER**

When draining oil/shortening into a disposal unit or portable filter unit, do not fill above the maximum fill line located on the container.

 **DANGER**

**NEVER** attempt to drain cooking oil or shortening from the fryer with the burner lit! Doing so will result in a flash fire if the oil or shortening splashes onto the burner. Also, applying burner heat to an empty frypot will severely damage the frypot and void all applicable warranties

 **DANGER**

**NEVER** attempt to clear a clogged drain valve from the front of the valve! Hot oil or shortening will rush out creating the potential for severe burns.

**DO NOT** hammer on the drain valve with the cleanout rod or other objects. Damage to the ball inside will result in leaks and will void all applicable warranties.

#### 3.4.1 Pan Preparation

See Section 3.2.1– Assembling the Filter, and Section 3.2.2– Installing the Filter

#### 3.4.2 Filter Operation

 **CAUTION**

**NEVER** operate the filter unit unless cooking oil/shortening is at operating temperature [ $\sim 350^{\circ}\text{F}$  ( $\sim 177^{\circ}\text{C}$ )].

1. Turn the fryer off. Ensure the filter pan assembly is prepared as described in Section 3.2.1– Assembling the Filter.

## YSCF14G- YFPH1814G SERIES GAS FRYERS CHAPTER 3: BUILT-IN FILTRATION

---

2. Remove fry baskets from frypot. Prior to filtering, skim any large debris from the shortening/oil. Use extreme caution, as shortening/oil is at or near operating temperature [ $\sim 350^{\circ}\text{F}$  ( $\sim 177^{\circ}\text{C}$ )].



Prior to filtering, skim any large debris from oil in frypot.

3. Remove the support grid from the frypot using the clean-out rod or tongs. Stir the oil with the L-shaped Teflon brush to suspend debris prior to draining.



Removing support grid from frypot prior to filtering.

## YSCF14G- YFPH1814G SERIES GAS FRYERS CHAPTER 3: BUILT-IN FILTRATION

### 3.4.2 Filter Operation (cont.)

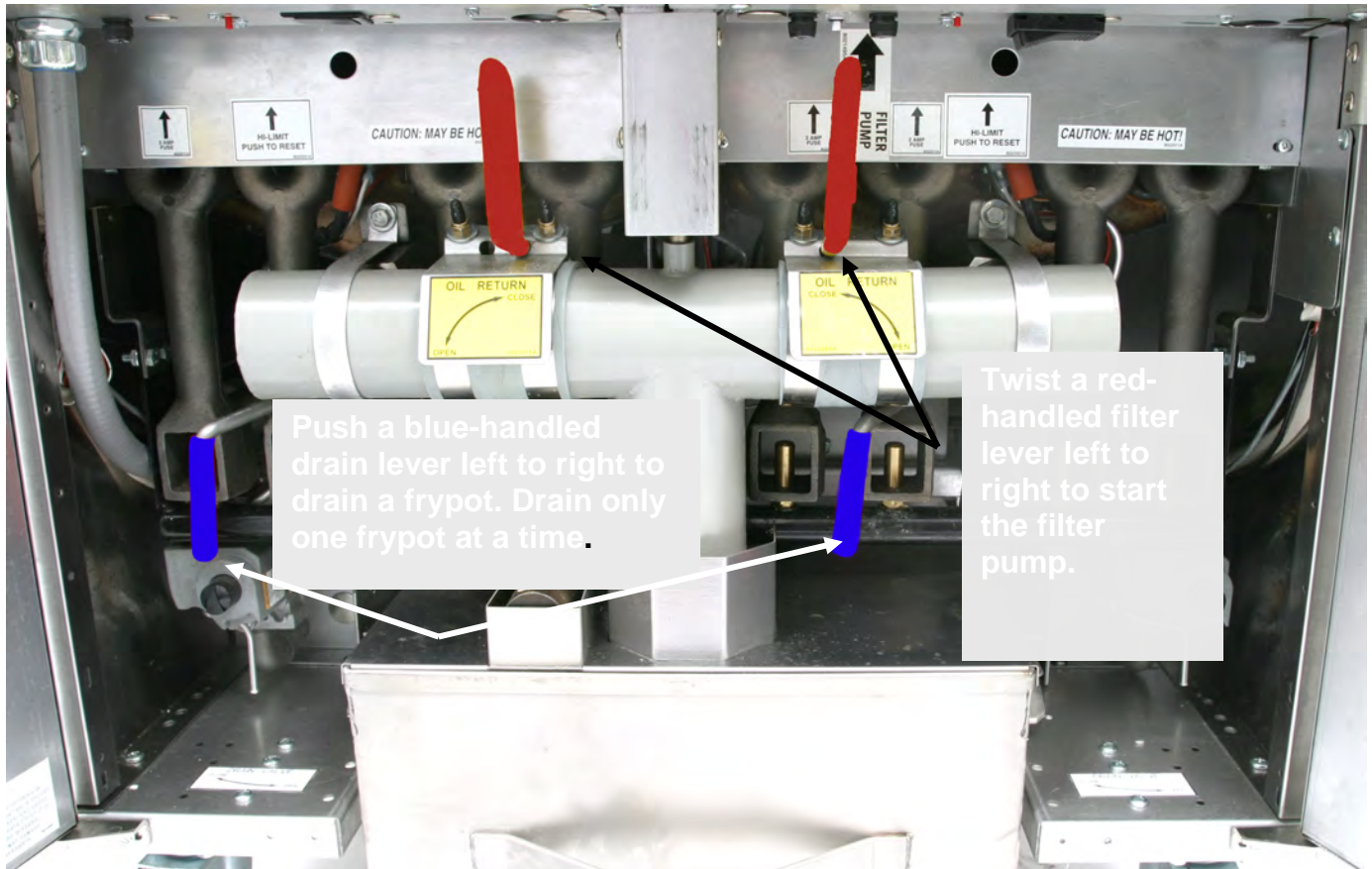

4. After ensuring the filter pan is correctly positioned under the drain tube and the pan are properly connected, drain the frypot into the filter pan. Drain only one frypot at a time.
5. After all oil has drained from the frypot into the filter pan, twist the red handle to open the oil return line and activate the filter pump.

## YSCF14G- YFPH1814G SERIES GAS FRYERS CHAPTER 3: BUILT-IN FILTRATION

---

### 3.4.2 Filter Operation (cont.)

- Oil will begin to pump from the filter pan into the frypot. If the frypot tubes, sides and bottom have sediment deposits, clean the frypot with the cleaning brush included with the fryer. Clean beneath and under the burner tubes, using care not to disturb the probes (arrow). Probe location will vary according to fryer system.



Clean all sediment and suspended particles from the burner tubes and frypot as the oil begins to circulate. Use care not to disturb the probes (arrow) on the burner tube.

- Allow the oil to circulate for approximately 30 minutes (process known as "polishing") to remove suspended particles.

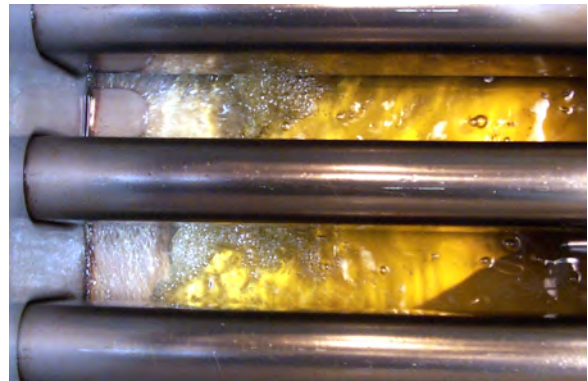

Polishing the oil removes suspended particles, which increases the life of the oil.

- After the filter cycle is complete, close the drain valve (push the blue handle fully to the left) and allow the fryer to refill.

## YSCF14G- YFPH1814G SERIES GAS FRYERS CHAPTER 3: BUILT-IN FILTRATION

---

### 3.4.2 Filter Operation (cont.)

9. After all oil is pumped back into the frypot, bubbles form, indicating air in the oil return lines. Allow the oil to bubble for 10-15 seconds to ensure all oil is evacuated from the return lines. Twist the red handle to close the oil return valve and deactivate the filter pump.



Allow the oil to bubble for 10-15 seconds to ensure evacuation of all shortening/oil in the return lines.

10. If the oil level is low, add oil until the level is at the top OIL LEVEL line. Remember, the oil is at operating temperature.



Add oil until the oil level is at the top OIL LEVEL line. DO NOT OVERFILL THE FRYPOT.

11. Replace the frypot grid, using care not to splash hot oil. Turn the fryer on.



Replace the frypot grid, using care not to splash hot oil.

**YSCF14G- YFPH1814G SERIES GAS FRYERS  
CHAPTER 3: BUILT-IN FILTRATION**

---

**3.4.2 Filter Operation (cont.)**

12. Do not allow crumbs to accumulate in the crumb tray. The crumb tray MUST be emptied into a fireproof container at the end of frying operations EACH day (see DANGER statement below).



Empty the filter pan crumb tray into a fire-proof container at the end of frying operations each day. DO NOT ALLOW CRUMBS TO ACCUMULATE IN TRAY.

**⚠ DANGER**

The crumb tray in fryers equipped with a filter system must be emptied into a fireproof container at the end of frying operations each day. Some food particles can spontaneously combust if left soaking in certain shortening material.

**⚠ WARNING**

Do not bang fry baskets or other utensils on the fryer's joiner strip. The strip is present to seal the joint between the frypots. Banging fry baskets on the strip to dislodge shortening will distort the strip, adversely affecting its fit. It is designed for a tight fit and should only be removed for cleaning.

# YSCF14G-YFPH1814G SERIES GAS FRYERS

## CHAPTER 4: COMPUTER OPERATION

### Overview

**NOTE:** See related computer manual (819-6943) and quick reference (819-6944).

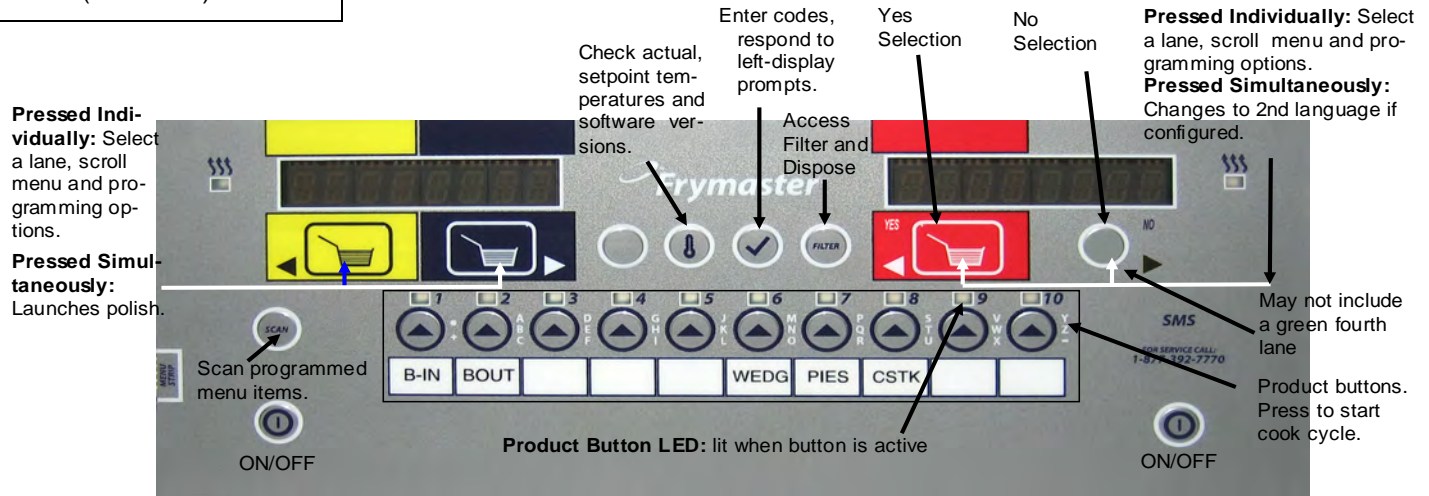

### Morning Operation

#### Turn Fryer ON

1. OFF appears in status display.
2. Press ON/OFF button.
3. Fryer heats to setpoint.
4. Polish Now? YES NO is displayed.
5. Press YES.
6. Follow prompts on controller.
7. OFF is displayed at end of polish cycle.
- 8: Turn fryer on. It heats to setpoint and displays READY.



#### Launch Cook Cycle

- 1: Press a lane key.
- 2: SELP (Select Product) appears in the window above the pressed button. The display changes to SEL PROD in about five seconds.
- 3: Press the menu key for the desired product.
- 4: The display changes to the cooktime for the product and then alternates between remaining cooktime and the product name.
- 5: DONE appears at the end of the cook cycle.

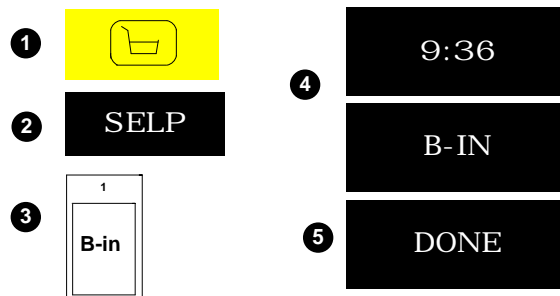

**NOTE:** To halt a cook cycle, press and hold the cook key under the displayed item for about five seconds.

# YSCF14G- YFPH1814G SERIES GAS FRYERS

## CHAPTER 5: PREVENTATIVE MAINTENANCE

---

### 5.1 General

 **DANGER**

**Never attempt to clean the fryer during the cooking process or when the frypot is filled with hot oil/shortening. If water comes in contact with oil/shortening heated to cooking temperature, it will cause spattering of the oil/shortening, which can result in severe burns to nearby personnel.**

Any equipment works better and lasts longer when maintained properly and kept clean. Cooking equipment is no exception. The YSCF14G-YFPH1814G Series gas fryer should be kept clean during the working day and thoroughly cleaned at the end of each day. Below are recommendations for daily, weekly and periodic preventative maintenance.

### 5.2 Daily

 **WARNING**

**Use a commercial grade cleaner formulated to effectively clean and sanitize food-contact surfaces. Read the directions and precautionary statements for use. Particular attention must be paid to the concentration of cleaner and the length of time the cleaner remains on the food-contact surfaces.**

- A. Remove and wash all removable parts.
- B. Clean all exterior surfaces of the cabinet. Do not use abrasive cleaners, steel wool, or any other abrasive material on stainless steel.
- C. Filter the cooking oil (See Chapter 3) and replace if necessary. The oil should be filtered more frequently when under heavy use.

### 5.3 Weekly

- A. Completely drain the oil from the fryer into a metal stockpot of sufficient size to safely hold the entire contents of the frypot for disposal. Do not use a glass or plastic container.
- B. Clean the frypot by following recommended store operational procedures.



## YSCF14G- YFPH1814G SERIES GAS FRYERS

### CHAPTER 5: PREVENTATIVE MAINTENANCE

---

#### 5.4 Periodic/Annual

**This appliance should be inspected and adjusted periodically by qualified service personnel as part of a regular kitchen maintenance program.**

**Frymaster recommends that this appliance be inspected at least annually by a Factory Authorized Servicer as follows:**

- Inspect the cabinet inside and out, front and rear for excessive oil build-up and/or oil migration.
- Verify that the flue opening is not obstructed by debris or accumulations of solidified oil or shortening.
- Verify that burners and associated components (i.e. gas valves, pilot assemblies, ignitors, etc.) are in good condition and functioning properly. Inspect all gas connections for leaks and verify that all connections are properly tightened.
- Verify that the burner manifold pressure is in accordance with that specified on the appliance's rating plate.
- Verify that the temperature and high-limit probes are properly connected, tightened and functioning properly, and that mounting hardware and probe guard are present and properly installed.
- Verify that component box components (i.e. computer/controller, transformers, relays, interface boards, etc.) are in good condition and free from oil migration build-up and other debris. Inspect the component box wiring and verify that connections are tight and that wiring is in good condition.
- Verify that all safety features (i.e. drain safety switches, reset switches, etc.) are present and functioning properly.
- Verify that the frypot/cookpot is in good condition and free of leaks and that the frypot/cookpot insulation is in serviceable condition. Verify that the frypot tube diffusers are present and in good condition (i.e. no visible deterioration or damage).
- Verify that wiring harnesses and connections are tight and in good condition.

#### **Built-in Filtration:**

- Inspect all oil-return and drain lines for leaks and verify that all connections are tight.
- Inspect the filter pan for leaks and cleanliness. Empty crumbs in the crumb basket into a fireproof container. Clean basket daily. Advise owner/operator not to allow crumbs to accumulate in basket. Insist they clean the basket daily.
- Verify that all O-rings and seals (including those on quick-disconnect fittings) are present and in good condition. Replace O-rings and seals if worn or damaged.

**YSCF14G- YFPH1814G SERIES GAS FRYERS  
CHAPTER 5: PREVENTATIVE MAINTENANCE**

---

## **5.4 Periodic/Annual (cont.)**

### **Built-in Filtration (cont.):**

- Check filtration system integrity as follows:
  - With the filter pan empty, place each oil return handle, one at a time, in the ON position. Verify that the pump activates and that bubbles appear in the cooking oil/shortening of the associated frypot.
  - Close all oil return valves (i.e., place all oil return handles in the OFF position). Verify proper functioning of each oil return valve by activating the filter pump using the lever on one of the oil return handle microswitches. No air bubbles should be visible in any frypot.
  - Verify that the filter pan is properly prepared for filtering, then drain a frypot of oil heated to 350°F (177°C) into the filter pan and close the frypot drain valve. Place the oil return handle in the ON position. Allow all cooking oil/shortening to return to the frypot (indicated by bubbles in the cooking oil/shortening). Return the oil return handle to the OFF position. The frypot should refill in no more than 2 minutes and 30 seconds.

**To ensure good fryer health and a safe environment, the fryer should be checked and adjusted periodically by qualified service personnel as part of a regular kitchen maintenance program.**

## **5.5 Stainless Steel Care**

 **WARNING**

**DO NOT let water splash into the tank of hot oil. It will splatter and can cause severe burns.**

All stainless steel fryer cabinet parts should be wiped regularly with hot, soapy water during the day, and with a liquid cleanser designed for stainless steel at the end of each day.

- A. Do not use steel wool, abrasive cloths, cleansers or powders.
- B. Do not use a metal knife, spatula or any other metal tool to scrape stainless steel! Scratches are almost impossible to remove.
- C. If it is necessary to scrape the stainless steel to remove any encrusted materials, soak the area first to soften the deposit, then use a wood or nylon scraper only.

# *Frymaster*<sup>®</sup>

FRYMASTER  
8700 LINE AVENUE, SHREVEPORT, LA 71106-6800

800-551-8633  
318-865-1711  
[WWW.FRYMASTER.COM](http://WWW.FRYMASTER.COM)  
EMAIL: [FRYSERVICE@WELBILT.COM](mailto:FRYSERVICE@WELBILT.COM)



Welbilt offers fully-integrated kitchen systems. Welbilt's portfolio of award-winning brands includes Cleveland™, Convotherm®, Crystal Tips®, Dean®, Delfield®, Fabristeel®, Frymaster®, Garland®, Inducs®, Koldtech®, Kolpak®, Lincoln®, McCann's™, Merco®, Merrychef®, Multiplex®, RDI®, SerVend™, SunFire®, U.S. Range™, and WMaxx™. Supported by service brands: FitKitchen®, kitchen systems; and KitchenConnect®, cloud-based open platform.

*Bringing innovation to the table* • [welbilt.com](http://welbilt.com)

©2023 Frymaster LLC. except where explicitly stated otherwise. All rights reserved. Continuing product improvement may necessitate change of specifications without notice.

Part Number FRY\_IOM\_8196132 06/2023