



# Frymaster BK1814E Series Electric Fryer Installation & Operation Manual



Frymaster, a member of the Commercial Food Equipment Service Association, recommends using CFESA Certified Technicians.

**24-Hour Service Hotline 1-800-551-8633**

06/2022

[www.frymaster.com](http://www.frymaster.com)

E-mail: [service@frymaster.com](mailto:service@frymaster.com)



**NOTICE**

IF, DURING THE WARRANTY PERIOD, THE CUSTOMER USES A PART FOR THIS FRYMASTER EQUIPMENT OTHER THAN AN UNMODIFIED NEW OR RECYCLED PART PURCHASED DIRECTLY FROM FRYMASTER, OR ANY OF ITS AUTHORIZED SERVICE CENTERS, AND/OR THE PART BEING USED IS MODIFIED FROM ITS ORIGINAL CONFIGURATION, THIS WARRANTY WILL BE VOID. FURTHER, FRYMASTER AND ITS AFFILIATES WILL NOT BE LIABLE FOR ANY CLAIMS, DAMAGES OR EXPENSES INCURRED BY THE CUSTOMER WHICH ARISE DIRECTLY OR INDIRECTLY, IN WHOLE OR IN PART, DUE TO THE INSTALLATION OF ANY MODIFIED PART AND/OR PART RECEIVED FROM AN UNAUTHORIZED SERVICE CENTER.

**NOTICE**

This appliance is intended for professional use only and is to be operated by qualified personnel only. A Frymaster Factory Authorized Servicer (FAS) or other qualified professional should perform installation, maintenance, and repairs. Installation, maintenance, or repairs by unqualified personnel may void the manufacturer's warranty. See Chapter 1 of this manual for definitions of qualified personnel.

**NOTICE**

This equipment must be installed in accordance with the appropriate national and local codes of the country and/or region in which the appliance is installed. See NATIONAL CODE REQUIREMENTS in Chapter 2 of this manual for specifics.

**NOTICE TO U.S. CUSTOMERS**

This equipment is to be installed in compliance with the basic plumbing code of the Building Officials and Code Administrators International, Inc. (BOCA) and the Food Service Sanitation Manual of the U.S. Food and Drug Administration.

**NOTICE**

Drawings and photos used in this manual are intended to illustrate operational, cleaning and technical procedures and may not conform to onsite management operational procedures.

**NOTICE TO OWNERS OF UNITS EQUIPPED WITH COMPUTERS**

**U.S.**

This device complies with Part 15 of the FCC rules. Operation is subject to the following two conditions: 1) This device may not cause harmful interference, and 2) This device must accept any interference received, including interference that may cause undesired operation. While this device is a verified Class A device, it has been shown to meet the Class B limits.

**CANADA**

This digital apparatus does not exceed the Class A or B limits for radio noise emissions as set out by the ICES-003 standard of the Canadian Department of Communications.

Cet appareil numérique n'émet pas de bruits radioélectriques dépassant les limites de classe A et B prescrites dans la norme NMB-003 édictée par le Ministre des Communications du Canada.

** DANGER**

Improper installation, adjustment, maintenance or service, and unauthorized alterations or modifications can cause property damage, injury, or death. Read the installation, operating, and service instructions thoroughly before installing or servicing this equipment.

**⚠ DANGER**

The front ledge of this appliance is not a step! Do not stand on the appliance. Serious injury can result from slips or contact with the hot oil.

**⚠ DANGER**

Do not store or use gasoline or other flammable liquids or vapors in the vicinity of this or any other appliance.

**⚠ DANGER**

The crumb tray in fryers equipped with a filter system must be emptied into a fireproof container at the end of frying operations each day. Some food particles can spontaneously combust if left soaking in certain shortening material.

**⚠ WARNING**

Do not bang fry baskets or other utensils on the fryer's joiner strip. The strip is present to seal the joint between the fry vessels. Banging fry baskets on the strip to dislodge shortening will distort the strip, adversely affecting its fit. It is designed for a tight fit and should only be removed for cleaning.

**⚠ DANGER**

Adequate means must be provided to limit the movement of this appliance without depending on or transmitting stress to the electrical conduit. A restraint kit is provided with single non-filter fryers. If the restraint kit is missing contact your local KES.

**⚠ DANGER**

Prior to movement, testing, maintenance and any repair on your Frymaster fryer, disconnect all electrical power from the fryer.

**⚠ WARNING**

No structural material on the fryer should be altered or removed to accommodate placement of the fryer under a hood. Questions? Call the Frymaster Service Hotline at 1-800-551-8633.

# FINDING YOUR WAY AROUND THE FRYMASTER BK1814E SERIES ELECTRIC FRYER

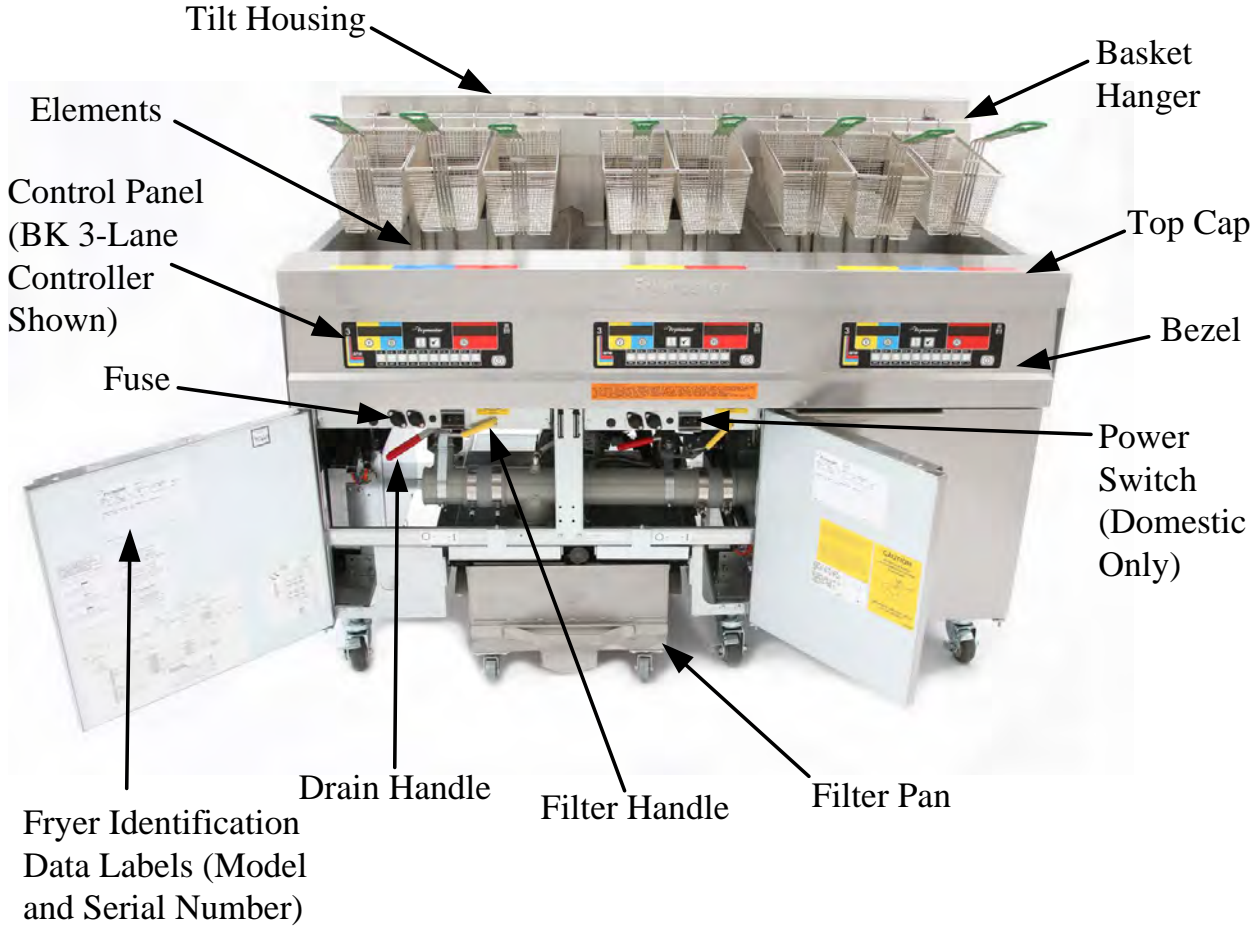

**TYPICAL CONFIGURATION (BK31814E SHOWN)**

**NOTE:** The appearance of your fryer may differ slightly from that shown depending upon the configuration and date of manufacture.



# BK1814E SERIES ELECTRIC FRYER Installation and Operation Manual

## TABLE OF CONTENTS

---

### **CHAPTER 1: Introduction**

|     |   |     |
|-----|---|-----|
| 1.1 | General Information .....                           | 1-1 |
| 1.2 | Safety Information.....                             | 1-1 |
| 1.3 | Controller Information .....                        | 1-1 |
| 1.4 | European Community (CE) Specific Information.....   | 1-2 |
| 1.5 | Installation, Operating and Service Personnel ..... | 1-2 |
| 1.6 | Definitions .....                                   | 1-2 |
| 1.7 | Shipping Damage Claim Procedure .....               | 1-3 |
| 1.8 | Service Information.....                            | 1-3 |

### **CHAPTER 2: Installation Instructions**

|     |   |     |
|-----|---|-----|
| 2.1 | General Installation Requirements ..... | 2-1 |
| 2.2 | Power Requirements.....                 | 2-3 |
| 2.3 | Positioning the Fryer Station.....      | 2-3 |

### **CHAPTER 3: Operating Instructions**

|     |  |     |
|-----|--|-----|
| 3.1 | Equipment Setup and Shutdown Procedures..... | 3-1 |
| 3.2 | Controllers .....                            | 3-2 |

### **CHAPTER 4: Filtration Instructions**

|       |   |      |
|-------|---|------|
| 4.1   | Draining and Manual Filtering .....       | 4-1  |
| 4.2   | General Filter Information.....           | 4-2  |
| 4.3   | Filter Preparation .....                  | 4-2  |
| 4.3.1 | Filter Components .....                   | 4-3  |
| 4.3.2 | Assembling the Filter .....               | 4-4  |
| 4.3.3 | Installing the Filter .....               | 4-6  |
| 4.4   | Daily Filter Operation .....              | 4-6  |
| 4.4.1 | General Overview.....                     | 4-6  |
| 4.4.2 | Filtering Tools .....                     | 4-7  |
| 4.5   | Operating the Filter .....                | 4-8  |
| 4.5.1 | Filter Operation .....                    | 4-8  |
| 4.6   | Draining and Disposing of Waste Oil ..... | 4-11 |

### **CHAPTER 5: Preventive Maintenance**

|       |  |     |
|-------|--|-----|
| 5.1   | Cleaning the Fryer .....                                   | 5-1 |
| 5.1.1 | Daily Cleaning Fryer Cabinet.....                          | 5-1 |
| 5.1.2 | Daily Cleaning Filtration System.....                      | 5-1 |
| 5.1.3 | Weekly Cleaning the Frypot and Elements.....               | 5-2 |
| 5.1.4 | Weekly Cleaning the Detachable Parts and Accessories ..... | 5-2 |
| 5.2   | Annual/Periodic System Inspection .....                    | 5-2 |

**CHAPTER 6: Operator Troubleshooting**

- 6.1 Introduction ..... 6-1
- 6.2 Troubleshooting..... 6-2
  - 6.2.1 Controller and Heating Problems ..... 6-2
  - 6.2.2 Troubleshooting Error Messages and Display Problems ..... 6-4
  - 6.2.3 Filtration Problems ..... 6-4
- 6.3 User Replaceable Parts..... 6-6

# FRYMASTER BK1814E SERIES ELECTRIC FRYER

## CHAPTER 1: INTRODUCTION

---

### 1.1 General

Read the instructions in this manual thoroughly before attempting to operate this equipment. This manual covers all configurations of BK1814E series electric fryers. The fryers in this model family have most parts in common, and when discussed as a group, will be referred to as “BK1814E” electric fryers.

The BK1814E electric fryers are open frypots that feature a rotating element with an enhanced design. Fryers in this series come in full pot arrangements, and can be purchased as single units without filters or grouped in batteries of up to three fryers with filtration.

### 1.2 Safety Information

Before attempting to operate your unit, read the instructions in this manual thoroughly.

Throughout this manual, you will find notations enclosed in double-bordered boxes similar to the one below.

 **DANGER**

**Hot cooking oil causes severe burns. Never attempt to move a fryer containing hot oil or to transfer hot oil from one container to another.**

 **CAUTION** boxes contain information about actions or conditions that *may cause or result in a malfunction of your system*.

 **WARNING** boxes contain information about actions or conditions that *may cause or result in damage to your system*, and which may cause your system to malfunction.

 **DANGER** boxes contain information about actions or conditions that *may cause or result in injury to personnel*, and which may cause damage to your system and/or cause your system to malfunction.

**Fryers in this series are equipped with the following automatic safety features:**

1. Two high-temperature detection features shut off power to the elements should the temperature controls fail.
2. A safety switch built into the drain valve prevents the elements from heating with the drain valve even partially open.

### 1.3 Controller Information

This equipment has been tested and found to comply with the limits for a Class A digital device, pursuant to Part 15 of the FCC rules. While this device is a verified Class A device, it has been

shown to meet the Class B limits. These limits are designed to provide reasonable protection against harmful interference when the equipment is operated in a commercial environment. This equipment generates, uses and can radiate radio frequency energy and, if not installed and used in accordance with the instruction manual, may cause harmful interference to radio communications. Operation of the equipment in a residential area is likely to cause harmful interference in which case the user will be required to correct the interference at their own expense.

The user is cautioned that any changes or modifications not expressly approved by the party responsible for compliance could void the user's authority to operate the equipment.

If necessary, the user should consult the dealer or an experienced radio and television technician for additional suggestions.

The user may find the following booklet prepared by the Federal Communications Commission helpful: "How to Identify and Resolve Radio-TV Interference Problems". This booklet is available from the U.S. Government Printing Office, Washington, DC 20402, Stock No. 004-000-00345-4.

#### **1.4 European Community (CE) Specific Information**

The European Community (CE) has established certain specific standards regarding equipment of this type. Whenever a difference exists between CE and non-CE standards, the information or instructions concerned are identified by means of shadowed boxes similar to the one below.

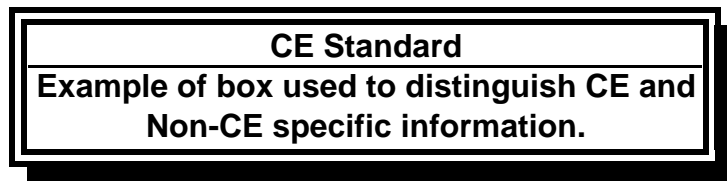

#### **1.5 Installation, Operating, and Service Personnel**

Operating information for Frymaster equipment has been prepared for use by qualified and/or authorized personnel only, as defined in Section 1.6. **All installation and service on Frymaster equipment must be performed by qualified, certified, licensed, and/or authorized installation or service personnel, as defined in Section 1.6.**

#### **1.6 Definitions**

##### **QUALIFIED AND/OR AUTHORIZED OPERATING PERSONNEL**

Qualified/authorized operating personnel are those who have carefully read the information in this manual and have familiarized themselves with the equipment functions, or who have had previous experience with the operation of the equipment covered in this manual.

##### **QUALIFIED INSTALLATION PERSONNEL**

Qualified installation personnel are individuals, firms, corporations, and/or companies which, either in person or through a representative, are engaged in and are responsible for the installation of



electrical appliances. Qualified personnel must be experienced in such work, be familiar with all electrical precautions involved, and have complied with all requirements of applicable national and local codes.

### **QUALIFIED SERVICE PERSONNEL**

Qualified service personnel are those who are familiar with Frymaster equipment and who have been authorized by Frymaster, L.L.C. to perform service on the equipment. All authorized service personnel are required to be equipped with a complete set of service and parts manuals, and to stock a minimum amount of parts for Frymaster equipment. A list of Frymaster Factory Authorized Servicers (FAS's) is located on the Frymaster website at [www.frymaster.com/service](http://www.frymaster.com/service). *Failure to use qualified service personnel will void the Frymaster warranty on your equipment.*

### **1.7 Shipping Damage Claim Procedure**

#### ***What to do if your equipment arrives damaged:***

Please note that this equipment was carefully inspected and packed by skilled personnel before leaving the factory. Frymaster does not assume responsibility for damage or loss incurred in transit. The freight company assumes full responsibility for safe delivery upon acceptance of the equipment.

1. File Claim for Damages Immediately—Regardless of extent of damage.
2. Visible Loss or Damage—Be sure this is noted on the freight bill or express receipt and is signed by the person making the delivery.
3. Concealed Loss or Damage—If damage is unnoticed until equipment is unpacked, notify the freight company or carrier immediately and file a concealed damage claim. This should be done within 15 days of date of delivery. Be sure to retain container for inspection.

### **1.8 Service Information**

For non-routine maintenance or repairs, or for service information, contact your local Frymaster Authorized Servicer (FAS). Service information may also be obtained by calling the Frymaster Technical Services Department (1-800-24FRYER) or by e-mail at [service@frymaster.com](mailto:service@frymaster.com). The following information will be needed in order to assist you efficiently:

Model Number \_\_\_\_\_

Serial Number \_\_\_\_\_

Voltage \_\_\_\_\_

Nature of the Problem \_\_\_\_\_

\_\_\_\_\_

\_\_\_\_\_

**RETAIN AND STORE THIS MANUAL IN A SAFE PLACE FOR FUTURE USE.**

# FRYMASTER BK1814E SERIES ELECTRIC FRYER

## CHAPTER 2: INSTALLATION INSTRUCTIONS

---

### 2.1 General

Proper installation is essential for the safe, efficient, trouble-free operation of this appliance.

Qualified, licensed, and/or authorized installation or service personnel, as defined in Section 1.6 of this manual, should perform all installation and service on Frymaster equipment.

**Failure to use qualified, licensed, and/or authorized installation or service personnel (as defined in Section 1.6 of this manual) to install or otherwise service this equipment will void the Frymaster warranty and may result in damage to the equipment or injury to personnel.**

Where conflicts exist between instructions and information in this manual and local or national codes or regulations, installation and operation shall comply with the codes or regulations in force in the country in which the equipment is installed.

Service may be obtained by contacting your local Factory Authorized Servicer.

#### NOTICE

All fryers shipped without factory supplied cords and plug assemblies must be hardwired using flexible conduit to the terminal block located on the rear of the fryer. These fryers should be wired to NEC specifications. Hardwired units must include installation of restraint devices.

#### NOTICE

If this equipment is wired directly into the electrical power supply, a means for disconnection from the supply having a contact separation of at least 3-mm in all poles must be incorporated in the fixed wiring.

#### NOTICE

This equipment must be positioned so that the plug is accessible unless other means for disconnection from the power supply (e.g., a circuit breaker) is provided.

#### NOTICE

If the electrical power supply cord is damaged, it must be replaced by a Frymaster Factory Authorized Servicer or a similarly qualified person in order to avoid a hazard.

#### DANGER

All wiring connections for this appliance must be made in accordance with the wiring diagram(s) furnished with the appliance. Refer to the wiring diagram(s) affixed to the inside of the appliance door when installing or servicing this equipment.

** DANGER**

**Do not attach an apron drainboard to a single fryer. The fryer may become unstable, tip over and cause injury. The appliance area must be kept free and clear of combustible material at all times.**

** DANGER**

**Building codes prohibit a fryer with its open tank of hot oil being installed beside an open flame of any type, including those of broilers and ranges.**

In the event of a power failure, the fryer(s) will automatically shut down. If this occurs, turn the power switch OFF. Do not attempt to start the fryer(s) until power is restored.

### **2.1.1 Clearance and Ventilation**

This appliance must be kept free and clear of combustible material.

A clearance of 6 inches (15cm) must be provided at both sides and back adjacent to combustible construction. A minimum of 24 inches (61cm) should be provided at the front of the equipment for servicing and proper operation.

** WARNING**

**Do not block the area around the base or under the fryers.**

### **2.1.2 Electrical Grounding Requirements**

All electrically operated appliances must be grounded in accordance with all applicable national and local codes, and, where applicable, CE codes. All units (cord connected or permanently connected) should be connected to a grounded power supply system. A wiring diagram is located on the inside of the fryer door. Refer to the rating plate on the inside of the fryer door for proper voltages.

### **2.1.3 Australian Requirements**

To be installed in accordance with AS 5601, local authority, gas, electricity, and any other relevant statutory regulations.

## 2.2 Power Requirements

| Three (3) Phase Requirements |         |              |                               |                |
|------------------------------|---------|--------------|-------------------------------|----------------|
| MODEL                        | VOLTAGE | WIRE SERVICE | MINIMUM WIRE SIZE<br>AWG (mm) | AMPS (per leg) |
| RE14/RE1814                  | 208     | 3            | 6 (4.11)                      | 39             |
| RE14/RE1814                  | 240     | 3            | 6 (4.11)                      | 34             |
| RE14/RE1814                  | 480     | 3            | 8 (2.59)                      | 17             |
| RE14/RE1814                  | 220/380 | 4            | 6 (4.11)                      | 21             |
| RE14/RE1814                  | 240/415 | 4            | 6 (4.11)                      | 20             |
| RE14/RE1814                  | 230/400 | 4            | 6 (4.11)                      | 21             |
| RE17/RE1814E                 | 208     | 3            | 6 (4.11)                      | 48             |
| RE17/RE1814E                 | 240     | 3            | 6 (4.11)                      | 41             |
| RE17/RE1814E                 | 480     | 3            | 6 (4.11)                      | 21             |
| RE17/RE1814E                 | 220/380 | 4            | 6 (4.11)                      | 26             |
| RE17/RE1814E                 | 240/415 | 4            | 6 (4.11)                      | 24             |
| RE17/RE1814E                 | 230/400 | 4            | 6 (4.11)                      | 25             |
| RE22/RE1822                  | 208     | 3            | 4 (5.19)                      | 61             |
| RE22/RE1822                  | 240     | 3            | 4 (5.19)                      | 53             |
| RE22/RE1822                  | 480     | 3            | 6 (4.11)                      | 27             |
| RE22/RE1822                  | 220/380 | 4            | 6 (4.11)                      | 34             |
| RE22/RE1822                  | 240/415 | 4            | 6 (4.11)                      | 31             |
| RE22/RE1822                  | 230/400 | 4            | 6 (4.11)                      | 32             |

| Single Phase Requirements |         |              |                               |                |
|---------------------------|---------|--------------|-------------------------------|----------------|
| MODEL                     | VOLTAGE | WIRE SERVICE | MINIMUM WIRE SIZE<br>AWG (mm) | AMPS (per leg) |
| RE14/RE1814               | 208     | 2            | 3 (5.83)                      | 68             |
| RE14/RE1814               | 240     | 2            | 4 (5.19)                      | 59             |
| RE14/RE1814               | 480     | 2            | 8 (3.26)                      | 30             |

### NOTICE

If this appliance is permanently connected to fixed wiring, it must be connected by means of copper wires having a temperature rating of not less than 167°F (75°C).

### DANGER

This appliance must be connected to a power supply having the same voltage and phase as specified on the rating plate located on the inside of the appliance door.

### DANGER

All wiring connections for this appliance must be made in accordance with the wiring diagram(s) furnished with the appliance. Refer to the wiring diagram(s) affixed to the inside of the appliance door when installing or servicing this equipment.

## 2.3 Positioning the Fryer

### DANGER

No structural material on the fryer should be altered or removed to accommodate placement of the fryer under a hood. Questions? Call the Frymaster Service Hotline at 1-800-551-8633.

1. Once the fryer has been positioned at the frying station, use a carpenter's level placed across the top of the frypot to verify that the unit is level, both side-to-side and front-to-back.

To level fryers, adjust the casters being careful to ensure the fryer(s) are at the proper height in the frying station.

When the fryer is leveled in its final position, install the restraints provided by the KES to limit its movement so that it does not depend on or transmit stress to the electrical conduit or connection. Install the restraints in accordance with the provided instructions. If the restraints are disconnected for service or other reasons, they must be reconnected before the fryer is used.

** DANGER**

**Adequate means must be provided to limit the movement of this appliance without depending on or transmitting stress to the electrical conduit. A restraint kit is provided with single non-filter fryers. If the restraint kit is missing contact your local KES.**

** DANGER**

**Hot oil can cause severe burns. Avoid contact. Under all circumstances, oil must be removed from the fryer before attempting to move it to avoid oil spills, falls and severe burns. This fryer may tip and cause personal injury if not secured in a stationary position.**

** WARNING**

**The on-site supervisor is responsible for ensuring that operators are made aware of the inherent hazards of operating a hot oil frying system, particularly the aspects of system operation, oil filtration, draining and cleaning procedures.**

2. New units are wiped clean with solvents at the factory to remove any visible signs of dirt, oil, grease, etc. remaining from the manufacturing process, then coated lightly with oil. Before any food preparation, wash thoroughly with hot, soapy water to remove any film residue and dust or debris then rinse out and wipe dry. Also wash any accessories shipped with the unit. Close the drain valve completely.
3. Fill frypot(s) to the bottom OIL LEVEL line scribed into the back of the frypot with cooking oil. (See *Equipment Setup and Shutdown Procedures* in Chapter 3.)

# FRYMASTER BK1814E SERIES ELECTRIC FRYER

## CHAPTER 3: OPERATING INSTRUCTIONS

---

### 3.1 Equipment Setup and Shutdown Procedures

#### Setup

 **DANGER**

Never operate the appliance with an empty frypot. The frypot must be filled to the fill line with water, oil or shortening before energizing the elements. Failure to do so will result in irreparable damage to the elements and may cause a fire.

 **DANGER**

Remove all drops of water from the frypot before filling with oil. Failure to do so will cause spattering of hot liquid when the oil is heated to cooking temperature.

1. Fill the frypot with oil to the bottom OIL LEVEL line located on the rear of the frypot. This will allow for oil expansion as heat is applied. Do not fill cold oil any higher than the bottom line; overflow may occur as heat expands the oil.

**NOTE:** If solid shortening is used, first raise the elements, then pack the shortening into the bottom of the frypot. Lower the elements, and then pack the shortening around and over the elements. It may be necessary to add shortening to bring the level up to the proper mark after the packed shortening has melted.

 **DANGER**

Never set a complete block of solid shortening on top of the heating elements.

When using solid shortening, always pre-melt the shortening before adding it to the frypot. If the shortening is not pre-melted, it must be packed down into the bottom of the frypot and between the elements, and the fryer must be started in the melt-cycle mode.

Never cancel the melt-cycle mode when using solid shortening. Doing so will result in damage to the elements and increase the potential for a flash fire.

2. Ensure that the power cord(s) is/are plugged into the appropriate receptacle(s). Verify that the face of the plug is flush with the outlet plate, with no portion of the prongs visible.
3. Ensure that the power is switched on. Some models are equipped with a master switch located behind the fryer door cabinet on the front panel of the component box, next to the fuse. See page 3-1. **OFF** is displayed on the controller.
4. Ensure that the controller is switched ON.
5. Ensure that the oil level is at the *top* OIL LEVEL line when the oil *is at its cooking temperature*. It may be necessary to add oil or shortening to bring the level up to the proper mark, *after it has reached cooking temperature*.

## **Shutdown**

1. Turn the fryer off.
2. Filter the cooking oil and clean the fryers (See Chapters 4 and 5).
3. Place the frypot covers on the frypots.

## **3.2 Controllers**

Refer to the separate controller manual furnished with your fryer for the specific controller operating instructions.

Refer to Chapter 4 of this manual for operating instructions for the built-in filtration system.

# FRYMASTER BK1814E SERIES ELECTRIC FRYER

## CHAPTER 4: FILTRATION INSTRUCTIONS

---

**⚠ WARNING**

Drawings and photos used in this manual are intended to illustrate operational, cleaning and technical procedures and may not conform to on-site management operational procedures.

**⚠ WARNING**

The on-site supervisor is responsible for ensuring that operators are made aware of the inherent hazards of operating a hot oil filtering system, particularly the aspects of oil filtration, draining and cleaning procedures.

### 4.1 Draining and Manual Filtering

**⚠ DANGER**

Draining and filtering of oil must be accomplished with care to avoid the possibility of a serious burn caused by careless handling. The oil to be filtered is at or near 350°F (177°C). Ensure all hoses are connected properly and drain handles are in their proper position before operating any switches or valves. Wear all appropriate safety equipment when draining and filtering oil.

**⚠ DANGER**

Allow oil to cool to 100°F (38°C) before draining into an appropriate container for disposal.

**⚠ DANGER**

Do not drain more than one frypot at a time into the built-in filtration unit to avoid overflow and spillage of hot oil.

**⚠ DANGER**

When draining oil into a disposal unit or portable filter unit, do not fill above the maximum fill line located on the container.

If your fryer is not equipped with a built-in filtration system, the oil must be drained into another suitable METAL container. (For safe, convenient draining and disposal of used oil or shortening, Frymaster recommends using the Frymaster Shortening Disposal Unit (SDU). The SDU is available through your local distributor.)

1. Turn the fryer power switch to the **OFF** position. Screw the drainpipe (provided with your fryer) into the drain valve. Make sure the drainpipe is firmly screwed into the drain valve and that the opening is pointing down.
2. Position a metal container with a sealable cover under the drainpipe. The metal container must be able to withstand the heat of the oil and hold hot liquids. If you intend to reuse



the oil or shortening, Frymaster recommends that a Frymaster filter cone holder and filter cone be used when a filter machine is not available. If you are using a Frymaster filter cone holder, be sure that the cone holder rests securely on the metal container.

3. Open the drain valve slowly to avoid splattering. If the drain valve becomes clogged with food particles, use the Fryer's Friend (poker-like tool) to clear the blockage.

 **DANGER**

**NEVER attempt to clear a clogged drain valve from the front of the valve! Hot oil will rush out creating the potential for severe burns.**

**DO NOT hammer on the drain valve with the cleanout rod or other objects. Damage to the ball inside will result in leaks and will void the Frymaster warranty.**

4. After draining the oil, clean all food particles and residual oil from the frypot. BE CAREFUL, this material may still cause severe burns if it comes in contact with bare skin.
5. Close the drain valve securely and fill the frypot with clean, filtered or fresh oil or solid shortening to the bottom OIL-LEVEL line.

 **DANGER**

**When using solid shortening, pack the shortening down into the bottom of the frypot. DO NOT operate the fryer with a solid block of shortening sitting in the upper portion of the frypot. This will cause damage to the frypot and may cause a flash fire.**

## 4.2 General Filtration Information

Most filter systems use filter paper as the filter medium. Filter powder is required to enhance the filtration process. Photos used in the procedural illustrations may differ from the filter unit that came with the frying system. The following procedures apply to all fryers equipped with filter systems. Filter system design depends on the frying system configuration.

## 4.3 Filter Preparation

On initial installation and before each use, clean the filter:

- a. Remove all loose parts from the filter,
- b. Wash the filter pan and all accessories in hot, soapy water,
- c. Dry thoroughly.

### 4.3.1 Filter Components

Filter paper is held in place by a hold-down ring. Oil moves through the paper, leaving behind impurities.

1. Filter pan.
2. Filter support grid.
3. Filter paper.
4. Hold-down ring.
5. Crumb screen.

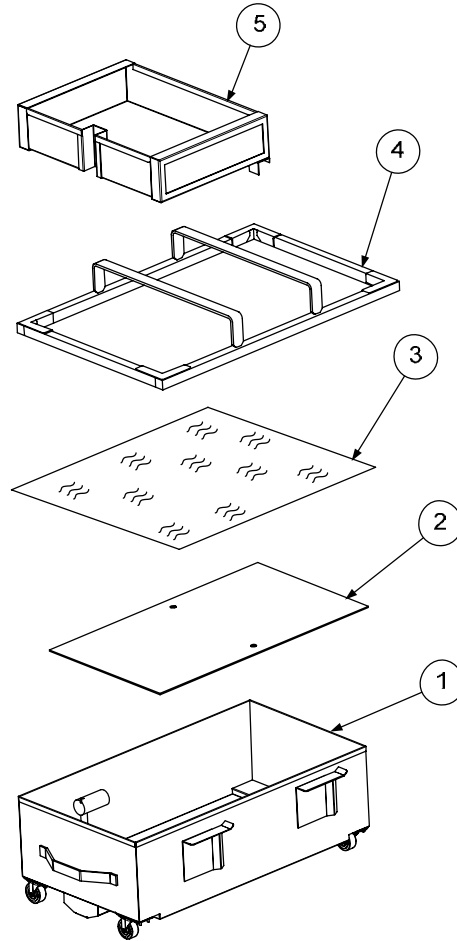

A filter unit which utilizes disposable filter paper to filter oil.

### 4.3.2 Assembling the Filter

1. Place the support grid in the bottom of filter pan.



Support grid properly placed in filter pan.

2. Put one filter paper sheet on top of the support grid. Be sure the paper covers the filter pan bottom and laps two inches onto the pan wall.



Ensure filter paper overlaps two inches on all sides and is evenly distributed under the hold-down ring.

3. Position the hold-down ring on top of the filter paper. Ensure the hold-down ring seals around the support grid. This prevents sediment from getting into the system.



Hold-down ring positioned correctly over filter paper in filter pan.

### 4.3.2 Assembling the Filter (cont.)

4. Sprinkle 8 ounces (227g) of filter powder on the filter sheet. Ensure the powder covers the filter paper evenly.



Sprinkle the proper amount of filter powder evenly over the paper.

5. Place the crumb screen in the filter pan. Allow the crumb screen to rest on the top edges of the hold-down ring.



Crumb screen properly placed.

6. Return filter pan to cabinet.

### 4.3.3 Installing the Filter

1. Slide the filter inside the fryer cabinet. Ensure the male-female pickup tubes are fully engaged. Ensure the filter pan opening is directly under the center dump tube.



The filter pan slides under the fryer (left), connecting with a male connector (right). Ensure that the pickup tube is securely coupled with this connector. Its location may vary based on model.



### 4.4 Daily Filter Operation

#### **WARNING**

**Use caution and wear proper protective clothing. The oil to be filtered is at or near 350°F (177°C). Ensure all hoses are connected properly and drain handles are in their proper position prior to operating any switches or valves. Failure to do this can result in severe burns.**

#### **WARNING**

**Drawings and photos used in this manual are intended to illustrate operational, cleaning and technical procedures and may not conform to on-site management operational procedures.**

#### 4.4.1 General Overview

Only filter oil at operating temperature (~350°F/~177°C). When filtering begins, the filter motor engages and oil is drawn through filter paper or a filter-leaf assembly and pumped back into the frypot through oil return plumbing. The frypot's drain remains open during the filtering process, allowing oil to filter through the frypot and back into the filter unit. Allow the oil to cycle through this process for approximately 5 minutes. At the end of 5 minutes, close the drain valve and allow the frypot to fill to the top OIL LEVEL line. Leave the pump running for 10-15 seconds after bubbles appear in the frypot to ensure all oil is pumped from the drain pan and the lines. Close the oil return valve.

#### 4.4.2 Filtering Tools

Assemble tools to be used for filtering. These are supplied with the filter starter kit included with the fryer/filter system:

- Frypot/Filter Brush - used to clean frypot and filter pan sides and bottom, heating elements, and to dislodge sediment during filtration or oil change.
- Clean-out Rod (design may vary) - used to dislodge heavy debris in the drain tube (when needed).
- Filter Powder.
- Filter Paper.

The following tools are not required, but are recommended to make the filtering task easier.

- Measuring Cup - used to measure filter powder.
- Stainless Steel Crumb Scoop - for removing large debris from oil prior to filtering.

 **CAUTION**

**Always wear oil-resistant, insulated gloves and/or protective gear when working with hot oil.**

## 4.5 Operating the Filter

### 4.5.1 Filter Operation

See Section 4.3.2, *Assembling the Filter*, and Section 4.3.3, *Installing the Filter*, for the appropriate filter preparation procedure.

**⚠ CAUTION**

**NEVER** operate the filter unit unless cooking oil is at operating temperature (~350°F/~177°C).

1. Ensure the filter pan assembly is prepared as described in Section 4.3.2, *Assembling the Filter*, and ensure fryer is turned off.
2. Remove fry baskets from frypot and skim any large debris from the oil. Use extreme caution, as oil is at or near operating temperature (~350°F/~177°C).



Prior to filtering, skim any large debris from oil in frypot.

3. Remove the basket support rack from the frypot using the Fryer's Friend clean-out rod. Stir the oil with the frypot/filter brush to suspend debris prior to draining.
4. After ensuring the filter pan is correctly positioned under the drain tubes, move the red handle to the open position (right) to drain the frypot into the filter pan. **Drain ONLY ONE frypot at a time. The filter pan is designed to hold the contents of one frypot only.** If necessary, use the *Fryer's Friend* clean-out rod to clear the drain from **inside** the frypot.



Removing basket support rack from frypot prior to filtering.



Move the red drain valve handle into the open position (right).

**⚠ DANGER**

**Do not drain more than one frypot at a time into the built-in filtration unit to avoid overflow and spillage of hot oil.**

**⚠ DANGER**

**NEVER attempt to clear a clogged drain valve from the front of the valve! Hot oil will rush out creating the potential for severe burns.**

#### 4.5.1 Filter Operation (cont.)

**⚠ WARNING**  
**DO NOT hammer on the drain valve with the cleanout rod or other objects. Damage to the ball inside will result in leaks and will void the Frymaster warranty.**

5. After all oil has drained from the frypot into the filter pan, turn the yellow handle (right) to open the oil return valve and activate the filter pump. Leave the red handle in the open position.
6. Oil will begin to pump from the filter pan into the frypot. If the frypot sides and bottom have sediment deposits, clean the frypot with the cleaning brush included with the fryer.
7. Allow the oil to circulate for approximately 5 minutes (process known as "polishing") to remove suspended particles.
8. After the filter cycle is complete, close the drain valve (push the red handle to the left until it stops) and allow the fryer to refill.
9. After all oil is pumped back into the frypot, bubbles will form, indicating air in the oil return lines. Allow the oil to bubble for 10-15 seconds to ensure all oil is evacuated from the return lines. Turn the yellow handle (left) to close the oil return valve and deactivate the filter pump.
10. If the oil level is low, add oil until the level is at the top OIL LEVEL line. **DO NOT OVERFILL THE FRYPOT.**

**⚠ WARNING**  
**DO NOT OVERFILL THE FYPOT. This will cause oil to splash out of the frypot during cooking and may cause burns or damage.**



Turn the yellow handle (right) to open the oil return valve and activate the filter pump.

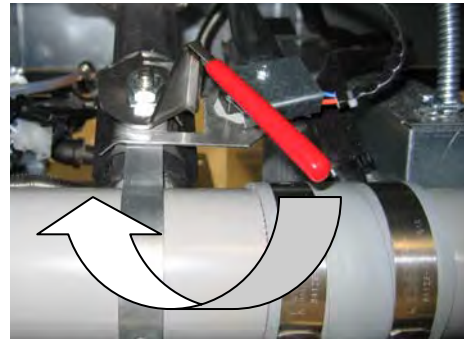

After filtering is complete, push the red drain handle (left) to close the drain and start refilling the frypot.



Allow the oil to bubble for 10-15 seconds to ensure evacuation of all oil in the return lines and turn the yellow handle to left to deactivate pump.



### 4.5.1 Filter Operation (cont.)

11. Lower the elements into the frypot.
12. Replace the basket support rack, using care not to splash hot oil.
13. Ensure the drain valve is fully closed. (If the drain valve is not fully closed, the fryer will not operate.) Turn the fryer ON and allow the oil to reach setpoint.
14. Do not allow crumbs to accumulate in the crumb tray. The crumb tray MUST be emptied into a fireproof container at the end of frying operations EACH DAY (see DANGER statement below).

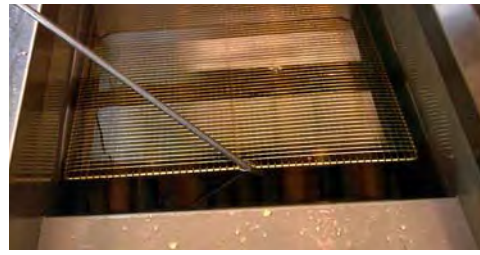

Replace the basket support rack, using care not to splash hot oil.



Empty the filter pan crumb tray into a fireproof container at the end of frying operations each day. DO NOT ALLOW CRUMBS TO ACCUMULATE IN TRAY.

#### DANGER

The crumb tray in fryers equipped with a filter system must be emptied into a fireproof container at the end of frying operations each day. Some food particles can spontaneously combust if left soaking in certain shortening material.

#### WARNING

Do not bang fry baskets or other utensils on the fryer's joiner strip. The strip is present to seal the joint between the fry vessels. Banging fry baskets on the strip to dislodge shortening will distort the strip, adversely affecting its fit. It is designed for a tight fit and should only be removed for cleaning.

#### WARNING

The filter pump is equipped with a manual reset switch in case the filter motor overheats or an electrical fault occurs. If this switch trips, turn off power to the filter system and allow the pump motor to cool 20 minutes before attempting to reset the switch (see photo below).

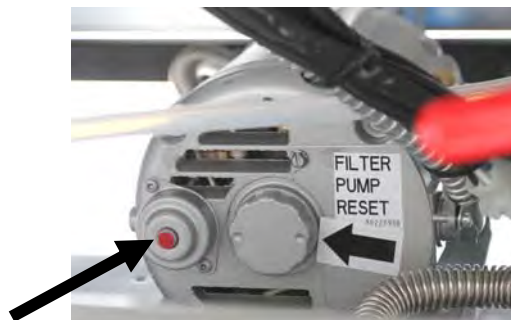

Filter Pump Reset Switch

#### 4.6 Draining and Disposing of Waste Oil

When your oil has reached the end of its usable life, drain the oil into an appropriate METAL container for transport to the disposal container. Frymaster recommends the use of the Frymaster Shortening Disposal Unit (SDU). Refer to the documentation furnished with your disposal unit for specific operating instructions. If a shortening disposal unit is not available, allow the oil to cool to 100°F (38°C), then drain the oil into a metal stockpot or similar metal container. When draining is finished, close the fryer drain valve securely.

 **DANGER**

**Allow oil to cool to 100°F (38°C) before draining into an appropriate METAL container for disposal.**

**When draining oil into a disposal unit, do not fill above the maximum fill line located on the container.**

# FRYMASTER BK1814E SERIES ELECTRIC FRYER

## CHAPTER 5: PREVENTATIVE MAINTENANCE

---

### 5.1 Cleaning the Fryer

 **DANGER**

The crumb tray in fryers equipped with a filter system must be emptied into a fireproof container at the end of frying operations each day. Some food particles can spontaneously combust if left soaking in certain shortening material.

 **DANGER**

Never attempt to clean the fryer during the frying process or when the frypot is filled with hot oil. If water comes in contact with oil heated to frying temperature, it will cause spattering of the oil, which can result in severe burns to nearby personnel.

 **WARNING**

Use a commercial-grade cleaner formulated to effectively clean and sanitize food-contact surfaces. Read the directions for use and precautionary statements before use. Particular attention must be paid to the concentration of cleaner and the length of time the cleaner remains on the food-contact surfaces.

#### 5.1.1 Clean Inside and Outside of the Fryer Cabinet – Daily

Clean inside the fryer cabinet with a dry, clean cloth. Wipe all accessible metal surfaces and components to remove accumulated oil and dust.

Clean outside the fryer cabinet with a clean, damp cloth soaked with detergent. Wipe with a clean, damp cloth.

#### 5.1.2 Clean the Built-in Filtration System – Daily

 **WARNING**

**Never drain water into the filter pan. Water will damage the filter pump.**

There are no periodic preventive maintenance checks and services required for your filtration system other than daily cleaning of the filter pan and associated components with a solution of hot water and detergent.

### 5.1.3 Clean the Frypot and Heating Elements- Weekly

Clean the frypot and heating elements to remove accumulated carbonized oil with detergent and water. Rinse and dry thoroughly.

#### **DANGER**

**Never operate the appliance with an empty frypot. The frypot must be filled to the fill line with water, oil or shortening before energizing the elements. Failure to do so will result in irreparable damage to the elements and may cause a fire.**

### 5.1.5 Clean Detachable Parts and Accessories – Weekly

Wipe all detachable parts and accessories with a clean, dry cloth. Use a clean cloth saturated with detergent to remove accumulated carbonized oil on detachable parts and accessories. Rinse the parts and accessories thoroughly with clean water and wipe dry before reinstalling.

## 5.2 Annual/Periodic System Inspection

**This appliance should be inspected and adjusted periodically by qualified service personnel as part of a regular kitchen maintenance program.**

**Frymaster recommends that this appliance be inspected at least annually by a Factory Authorized Servicer as follows:**

### **Fryer**

- Inspect the cabinet inside and out, front and rear for excessive oil.
- Verify that the heating element wires are in good condition and that leads have no visible fraying or insulation damage and that they are free of oil.
- Verify that heating elements are in good condition with no carbon/caramelized oil build-up. Inspect the elements for signs of extensive dry-firing.
- Verify that the tilt mechanism is working properly when lifting and lowering elements, and that the element wires are not binding and/or chafing.
- Verify the heating-element amp-draw is within the allowed range as indicated on the appliance's rating plate.
- Verify that the temperature and high-limit probes are properly connected, tightened and functioning properly, and that mounting hardware and probe guards are present and properly installed.
- Verify that component box and contactor box components (i.e. controller, relays, interface boards, transformers, contactors, etc.) are in good condition and free from oil and other debris.
- Verify that component box and contactor box wiring connections are tight and that wiring is in good condition.

- Verify that all safety features (i.e. contactor shields, drain safety switches, reset switches, etc.) are present and functioning properly.
- Verify that the frypot is in good condition and free of leaks and that the frypot insulation is in serviceable condition.
- Verify that all wiring harnesses and connections are tight and in good condition.

### **Built-In Filtration System**

- Inspect all oil-return and drain lines for leaks and verify that all connections are tight.
- Inspect the filter pan for leaks and cleanliness. If there is a large accumulation of crumbs in the crumb basket, advise the owner/operator that the crumb basket should be emptied into a fireproof container and cleaned daily.
- Verify that all O-rings and seals (including those on the quick-disconnect fittings) are present and in good condition. Replace O-rings and seals if worn or damaged.
- Check filtration system integrity as follows:
  - Verify that filter pan cover is present and properly installed.
  - With the filter pan empty, place each oil return handle, one at a time, in the ON position. Verify that the pump activates and that bubbles appear in the oil of the associated frypot.
  - Close all oil return valves (i.e., place all oil return handles in the OFF position). Verify proper functioning of each oil return valve by activating the filter pump using the lever on one of the oil return handle microswitches. No air bubbles should be visible in any frypot.
  - Verify that the filter pan is properly prepared for filtering, then drain a frypot of oil heated to 350°F (177°C) into the filter pan and close the frypot drain valve. Place the oil return handle in the ON position. Allow all oil to return to the frypot, indicated by bubbles in the oil. Return the oil return handle to the OFF position. The frypot should have refilled in no more than 2 minutes and 30 seconds.

# FRYMASTER 1814E SERIES ELECTRIC FRYER

## CHAPTER 6: OPERATOR TROUBLESHOOTING

---

### 6.1 Introduction

This section provides an easy reference guide to some of the common problems that may occur during the operation of this equipment. The troubleshooting guides that follow are intended to help correct, or at least accurately diagnose, problems with this equipment. Although the chapter covers the most common problems reported, you may encounter problems that are not covered. In such instances, the Frymaster Technical Services staff will make every effort to help you identify and resolve the problem.

When troubleshooting a problem, always use a process of elimination starting with the simplest solution and working through to the most complex. Never overlook the obvious – anyone can forget to plug in a cord or fail to close a valve completely. Most importantly, always try to establish a clear idea of why a problem has occurred. Part of any corrective action involves taking steps to ensure that it doesn't happen again. If a controller malfunctions because of a poor connection, check all other connections, too. If a fuse continues to blow, find out why. Always keep in mind that failure of a small component may often be indicative of potential failure or incorrect functioning of a more important component or system.

***Before calling a service agent or the Frymaster HOTLINE (1-800-551-8633):***

- **Verify that electrical cords are plugged in and that circuit breakers are on.**
- **Verify that frypot drain valves are fully closed.**

 **DANGER**

**Hot oil will cause severe burns. Never attempt to move this appliance when filled with hot oil or to transfer hot oil from one container to another.**

 **DANGER**

**This equipment should be unplugged when servicing, except when electrical circuit tests are required. Use extreme care when performing such tests.**

**This appliance may have more than one electrical power supply connection point. Disconnect all power cords before servicing.**

**Inspection, testing, and repair of electrical components should be performed by an authorized service agent only.**

## 6.2 Troubleshooting

### 6.2.1 Controller and Heating Problems

| Problem   | Probable Causes  | Corrective Action   |
|---|--|---|
| <b>Controller won't activate.</b>                                 | A. Power cord is not plugged in or circuit breaker is tripped.         | A. Plug power cord in and verify that circuit breaker is not tripped.   |
|   | B. Controller or power supply component or interface board has failed. | B. Call a FAS.  |
| <b>Fryer does not heat.</b>                                       | A. Drain valve is open.  | A. A drain safety switch prevents the heating element from being energized if the drain valve is not fully closed. Verify that the drain valve is fully closed.   |
|   | B. One or more other components have failed.                           | B. Call a FAS.  |
| <b>Fryer repeatedly cycles on and off when first started.</b>     | Fryer is in melt-cycle mode.   | This is normal. The default operational mode is for the elements to cycle on and off until the temperature in the frypot reaches 180°F (82°C). <b>-LO-</b> or <b>MELT-CYCLE</b> will appear in the display when in the melt-cycle mode. The purpose of the melt-cycle is to allow controlled melting of solid shortening to prevent scorching and flash fires or damage to the element. If you are not using solid shortening, the melt-cycle can be bypassed. Press the “Y” yellow key to bypass melt cycle. To disable the melt cycle press the check button with the controller off. Enter 1751. To enable melt cycle bypass, press the check button with the controller off and enter 1753. |
| <b>Fryer does not heat after filtering.</b>                       | Drain valve is open.   | This fryer is equipped with a drain safety switch that prevents the heating element from being energized if the drain valve is not fully closed. Verify that the drain valve is fully closed.   |
| <b>Fryer heats until high limit trips with heat indicator ON.</b> | Temperature probe or controller has failed.                            | Turn fryer off and call a FAS.  |

| <b>Problem</b>   | <b>Probable Causes</b>                             | <b>Corrective Action</b> |
|--|--|--------------------------|
| <b>Fryer heats until high limit trips without heat indicator ON.</b> | Contactors or controller has failed.               | Call a FAS.              |
| <b>Fryer stops heating with heat indicator ON.</b>                   | The high limit thermostat or contactor has failed. | Call a FAS.              |

## 6.2.2 Error Messages and Display Problems

| <b>Problem</b>  | <b>Probable Causes</b>  | <b>Corrective Action</b>   |
|---|---|--|
| <b>Display is in wrong temperature scale (Fahrenheit or Celsius).</b> | Incorrect display option programmed.  | Controller may be programmed to display in either Fahrenheit or Celsius. With the controller off, press the check button and enter 1658.   |
| <b>Display shows <i>HI</i>.</b>                                       | Fryer is more than 21°F (12°C) above setpoint.                                    | This display is normal if the fryer setpoint has been changed to a lower temperature. The display should revert to the normal four dashes when the frypot temperature cools to the setpoint. If the setpoint has not been changed, this indicates a problem with the temperature control circuitry. Turn the fryer off and call a FAS. |
| <b>Display shows <i>HOT</i>.</b>                                      | Frypot temperature is more than 410°F (210°C) or, in CE countries, 395°F (202°C). | This is an indication of a malfunction in the temperature control circuitry, including a failure of the high limit thermostat. Shut the fryer down immediately and call a FAS.   |
| <b>Display shows <i>LO</i>.</b>                                       | Frypot temperature is more than 21°F (12°C) below setpoint.                       | This display is normal when the fryer is first turned on and may appear for a short while if a large batch of frozen product is added to the frypot. If the display never goes out, the fryer is not heating call a FAS.   |



### 6.2.3 Filtration Problems

| Problem  | Probable Causes  | Corrective Action  |
|--|--|--|
| <p><b>Filter pump won't start.</b></p>   | <p>A. Power cord is not plugged in or circuit breaker is tripped.</p>  | <p>A. Verify that the power cord is fully plugged in. If so, verify that circuit breaker is not tripped.</p>   |
|  | <p>B. Pump motor has overheated causing the thermal overload switch to trip.</p>   | <p>B. If the motor is too hot to touch for more than a few seconds, the thermal overload switch has probably tripped. Allow the motor to cool at least 45 minutes then press the Pump Reset Switch.</p>  |
|  | <p>C. Blockage in filter pump.</p> <p><b>Test:</b> Close the drain valve and pull the filter pan out from the fryer. Activate the pump. If the pump motor hums for a short time then stops, the probable cause is blockage of the pump itself.</p> | <p>C. Pump blockages are usually caused by sediment buildup in the pump due to improperly sized or installed filter paper and failure to use the crumb screen. Call a FAS.</p>   |
| <p><b>Filter pump runs but oil does not return to frypot and there is no bubbling oil.</b></p> | <p>Blockage in filter pan suction tube.</p> <p><b>Test:</b> Close the drain valve and pull the filter pan out from the fryer. Activate the pump. If bubbling oil occurs, there is a blockage in the filter pan suction tube.</p>                   | <p>The blockage may be caused by sediment buildup or, if solid shortening is used, solidified shortening in the tube. Use a thin, flexible wire to remove the blockage. If the blockage cannot be removed, call a FAS.</p>   |
| <p><b>Filter pump runs, but oil return is very slow and bubbling oil occurs.</b></p>           | <p>A. Improperly installed filter pan components.</p>  | <p>A. If using filter paper or pad configuration, verify that filter screen is in bottom of pan with paper or pad on top of screen.</p> <p>Verify that O-rings are present and in good condition on filter pan connection fitting.</p> <p>If using Magnasol filter assembly, verify that O-ring is present and in good condition on filter screen fitting.</p> |

| <b>Problem</b> | <b>Probable Causes</b>                                   | <b>Corrective Action</b>  |
|----------------|--|---|
|                | B. Attempting to filter with oil that is not hot enough. | B. In order to properly filter, the oil or shortening should be at or near 350°F (177°C). At temperatures lower than this, the oil becomes too thick to pass through the filter medium easily, resulting in much slower oil return and eventual overheating of the filter pump motor. Make sure oil is at or near frying temperature before draining oil into filter pan. |

### 6.3 User Replaceable Parts

| <b>User Replaceable Parts</b> |                                |
|-------------------------------|--------------------------------|
| <b>Part Number</b>            | <b>Description</b>             |
| 230-8464                      | Basket hanger 21814E           |
| 230-8319                      | Basket hanger 1814E/RE/1814E   |
| 230-8463                      | Basket hanger 1814E/RE         |
| 230-8462                      | Basket hanger RE/1814E         |
| 230-4318                      | Basket hanger 1814E Non-Filter |
| 108-1872                      | Vat cover 1814E                |
| 806-3068                      | Vat cover RE FV                |
| 806-3071                      | Vat cover RE DV                |
| 823-5772                      | Frypot joiner strip            |
| 823-7619                      | Splash guard                   |
| 803-0278                      | L-shaped brush                 |
| 803-0197                      | Fryers' friend                 |
| <b>Filter Pan Components</b>  |                                |
| 823-7425                      | Crumb tray                     |
| 810-3541                      | Hold-down ring                 |
| 200-8003                      | Sana grid screen               |
| 108-1582                      | Filter pan                     |
| 823-7418                      | Filter pan lid                 |
| 803-0289                      | Filter paper                   |

**THIS PAGE INTENTIONALLY LEFT BLANK**



FRYMASTER  
8700 LINE AVENUE, SHREVEPORT, LA 71106-6800

800-551-8633  
318-865-1711

[WWW.FRYMASTER.COM](http://WWW.FRYMASTER.COM)

EMAIL: [FRYSERVICE@WELBILT.COM](mailto:FRYSERVICE@WELBILT.COM)



Welbilt offers fully-integrated kitchen systems and our products are backed by KitchenCare® aftermarket parts and service. Welbilt's portfolio of award-winning brands includes **Cleveland™, Convotherm®, Crem®, Delfield®, fitkitchen®, Frymaster®, Garland®, Kolpak®, Lincoln®, Merco®, Merrychef® and Multiplex®.**

*Bringing innovation to the table* • [welbilt.com](http://welbilt.com)

©2022 Welbilt Inc. except where explicitly stated otherwise. All rights reserved. Continuing product improvement may necessitate change of specifications without notice.

Part Number FRY\_IOM\_8196810 06/2022