

# *Frymaster*<sup>®</sup>

*We Fit the Way You Fry*<sup>™</sup>

## **ESG35T**

### **Gas Fryer**

# **Installation, Operation and Maintenance Manual**

This manual is updated as new information and models are released. Visit our website for the latest manual.



#### **FOR YOUR SAFETY**

**Do Not Store or use gasoline  
or other flammable vapors  
and liquids in the vicinity of  
this or any other appliance.**

#### **⚠ CAUTION**

**READ THE INSTRUCTIONS BEFORE USING THE FRYER.**

**Keep these instructions for future reference.**



Part Number: FRY\_IOM\_8197680 02/2025

Original Instructions



**NOTICE**

This appliance is intended for professional use only and is to be operated by qualified personnel only. A Frymaster Factory Authorized Servicer (FAS) or other qualified professional should perform installation, maintenance, and repairs. Installation, maintenance, or repairs by unqualified personnel may void the manufacturer's warranty.

**NOTICE**

This equipment must be installed in accordance with the appropriate national and local codes of the country and/or region in which the appliance is installed.

**NOTICE TO U.S. CUSTOMERS**

This equipment is to be installed in compliance with the basic plumbing code of the Building Officials and Code Administrators International, Inc. (BOCA) and the Food Service Sanitation Manual of the U.S. Food and Drug Administration.

**⚠ DANGER**

Improper installation, adjustment, maintenance or service, and unauthorized alterations or modifications can cause property damage, injury, or death. Read the installation, operating, and service instructions thoroughly before installing or servicing this equipment. Only qualified service personnel may convert this appliance to use a gas other than that for which it was originally configured.

**⚠ DANGER**

The front ledge of the fryer is not a step! Do not stand on the fryer. Serious injury can result from slips or contact with the hot oil.

**⚠ DANGER**

Do not store or use gasoline or other flammable liquids or vapors in the vicinity of this or any other appliance.

**⚠ DANGER**

Instructions to be followed in the event the operator smells gas or otherwise detects a gas leak must be posted in a prominent location. This information can be obtained from the local gas company or gas supplier.

**NOTICE**

IF, DURING THE WARRANTY PERIOD, THE CUSTOMER USES A PART FOR THIS FRYMASTER DEAN EQUIPMENT OTHER THAN AN UNMODIFIED NEW OR RECYCLED PART PURCHASED DIRECTLY FROM FRYMASTER DEAN, OR ANY OF ITS AUTHORIZED SERVICERS, AND/OR THE PART BEING USED IS MODIFIED FROM ITS ORIGINAL CONFIGURATION, THIS WARRANTY WILL BE VOID. FURTHER, FRYMASTER DEAN AND ITS AFFILIATES WILL NOT BE LIABLE FOR ANY CLAIMS, DAMAGES OR EXPENSES INCURRED BY THE CUSTOMER WHICH ARISE DIRECTLY OR INDIRECTLY, IN WHOLE OR IN PART, DUE TO THE INSTALLATION OF ANY MODIFIED PART AND/OR PART RECEIVED FROM AN UNAUTHORIZED SERVICER.

**⚠ WARNING**

This appliance is not intended for use by children under the age of 16 or persons with reduced physical, sensory or mental capabilities, or lack of experience and knowledge, unless they have been given supervision concerning use of the appliance by a person responsible for their safety. Do not allow children to play with this appliance.

**NOTICE**

The Commonwealth of Massachusetts requires any and all gas products to be installed by a licensed plumber or pipe fitter.

**⚠ WARNING**

After installation of a gas fryer and after any maintenance to the gas system of a gas fryer-manifold, valve, burners, etc. – check for gas leaks at all connections. Apply a thick soapy solution to all connections and ensure there are no bubbles. There should be no smell of gas.

**⚠ DANGER**

When installed, this appliance must conform with local codes, or in the absence of local codes, with the National Fuel Gas Code, ANSI Z223.1/NFPA54, or the Natural Gas and Propane Installation Code, CSA B149.1 as applicable or the appropriate national code of the country in which installed.

**NOTICE**

The appliance must be installed and used in such a way that any water cannot contact the fat or oil.

 **WARNING**

Use caution and wear appropriate safety equipment to avoid contact with hot oil or surfaces that may cause severe burns or injury.

 **WARNING**

Operation, installation, and servicing of this product may expose you to chemicals/products including [Bisphenol A (BPA), glass wool or ceramic fibers, and crystalline silica], which is [are] known to the State of California to cause cancer, birth defects or other reproductive harm. For more information go to [www.P65Warnings.ca.gov](http://www.P65Warnings.ca.gov).

 **WARNING**

Do not leave the fryer unattended during use.

 **WARNING**

Do not overfill the frypot to avoid overflow of hot oil that may cause severe burns, slipping and falling.

 **WARNING**

Use caution and wear appropriate safety equipment when adding oil to the fryer, to prevent splashing of hot oil, which may cause severe burns.

 **DANGER**

Adequate means must be provided to limit the movement of the appliance without depending upon the gas line connector and the quick-disconnect device or its associated piping to limit the appliance movement. Single fryers equipped with legs must be stabilized by installing anchor straps

All fryers equipped with casters must be stabilized by installing restraining chains. If a flexible gas line is used, an additional restraining cable must be connected at all times when the fryer is in use.

All fryers equipped with casters must be installed using a connector that complies with the Standard for Connectors for Moveable Gas Appliances, ANSI Z21.69 or CSA 6.16, and a quick-disconnect device that complies with the Standard for Quick-Disconnect Devices for Use with Gas Fuel, ANSI Z21.41 or CSA 6.9.

**NOTICE**

This equipment must be installed in accordance with the appropriate national and local codes of the country and/or region in which the appliance is installed. For the United States and Canada these are the National Fuel Gas Code, ANSI Z233.1/NFPA 54, or the Natural Gas and Propane Installation Code, CSA B149.1. See NATIONAL CODE REQUIREMENTS in Chapter 2 of this manual for specifics.

The gas manifold of this appliance or of the battery of which it is a part must be connected to a gas appliance pressure regulator adjusted for the manifold pressure marked on the rating plate.

The appliance and its individual shutoff valve must be disconnected from the gas supply piping system during any pressure testing of that system at test pressures in excess of ½ psi (3.5 kPa/13.84 inches W.C.).

The appliance must be isolated from the gas supply piping system by closing its individual manual shutoff valve during any pressure testing of the gas supply piping system at test pressures equal to or less than ½ psi (3.5 kPa/13.84 inches W.C.).

# ESG35T

## CHAPTER 1: INSTALLATION INSTRUCTIONS

---

### 1.1 Safety Information

Before attempting to operate your unit, read the instructions in this manual thoroughly. Throughout this manual you will find notations enclosed in double-bordered boxes with the symbol . The information contained in the box concerns actions or conditions that may cause or result in injury to personnel or damage to your system, and/or cause your system to malfunction.

### 1.2 General Installation Instructions

 **DANGER**  
Building codes prohibit a fryer with its open frypot of hot oil being installed beside an open flame of any type, including those of broilers and ranges.

 **DANGER**  
This appliance must be installed with sufficient ventilation to prevent the occurrence of unacceptable concentrations of substances harmful to the health of personnel in the room where it is installed.

 **DANGER**  
No structural material on the fryer should be altered or removed to accommodate placement of the fryer under a hood.

 **DANGER**  
Single fryers must be restrained to prevent tipping when installed in order to avoid the splashing of hot liquid. The means of restraint may be the manner of installation, such as connection to battery of appliances or installing the fryer in an alcove, or by separate means, such as straps or chains.

 **DANGER**  
Do not attach an apron drainboard to a single unit. The appliance may become unstable, tip over, and cause injury. The appliance area must be free and clear of combustible material at all times.

**NOTICE**  
This appliance is only for professional use and shall be used by qualified personnel only.

### CLEARANCE AND VENTILATION

This fryer must be installed with a 6-inch (150-mm) clearance at both sides and back when installed adjacent to combustible construction. No clearance is required when installed adjacent to non-combustible construction. A minimum of 24-inches (600-mm) clearance should be provided at the front of the fryer.

The fryer flue opening must not be placed close to the intake of an exhaust fan, and the fryer must never have its flue extended in a "chimney" fashion. An extended flue will change the combustion characteristics of the fryer. To provide the airflow necessary for good combustion and burner operation, the areas surrounding the fryer front, sides, and rear must be kept clear and unobstructed.

The fryer must be installed in an area with an adequate air supply and adequate ventilation. Adequate distances must be maintained from the flue outlet of the fryer to the lower edge of the ventilation filter bank. Filters should be installed at an angle of 45°. Place a drip tray beneath the lowest edge of the filter. For U.S. installation, NFPA standard No. 96 states, "A minimum distance of 18-inches (450-mm) should be maintained between the flue outlet and the lower edge of the grease filter". *Frymaster recommends that the minimum distance be 24-inches (600-mm) from the flue outlet to the bottom edge of the filter.*

**ESG35T**  
**CHAPTER 1: INSTALLATION INSTRUCTIONS**

---

**INSTALLATION**

**NOTE:** Unless special ordered, this fryer is designed for operation at altitudes of 2000 feet (610 meters) and below. The unit must be modified for operation above 2000 feet (610 meters).

For units equipped with legs: Lift the unit and move it into its final position. Do not drag or push the fryer into position. Doing so may damage the legs. Level the unit front to back and side to side. If the fryer is not level, the unit will not function efficiently. ESG Series gas fryers cannot be curb mounted and must be equipped with either legs or casters provided.

- A. Adjust leg height with an adjustable or 1-1/16-inch (27-mm) open-end wrench by turning the hexagon-shaped foot on the bottom of the leg. **NOTE:** The foot is for minor leg height adjustment only. **Do not adjust outward more than 3/4-inch (19-mm).**
- B. When leveling the unit, the leg body should be held firmly to keep the leg from bending or rotating while turning the foot to the required height.

For units equipped with casters: Roll the unit into its final position and lock the front casters.

**1.3 Unpacking Equipment**

- A. Check that the container is upright. Use an outward prying motion - **no hammering** - to remove the carton. Unpack the fryer carefully and remove all accessories from the carton. Do not discard or misplace these, as they will be needed.
- B. After unpacking, immediately check the equipment for visible signs of shipping damage. If damage has occurred, contact the carrier and file the appropriate freight claims. Do not contact the factory. Shipping damage responsibility is between the carrier and the dealer.

**If your equipment arrives damaged:**

- 1. File claim for damages immediately, regardless of extent of damage.
- 2. Visible loss or damage: Be sure this is noted on the freight bill or express receipt and is signed by the person making the delivery.
- 3. Concealed loss or damage: If damage is unnoticed until equipment is unpacked, notify freight company or carrier immediately, and file a concealed damage claim. This should be done within 5 days of date of delivery. Be sure to retain container and all packing materials for inspection.

**NOTE: Dean Does Not Assume Responsibility for Damage or Loss Incurred in Transit.**

- C. **Frying systems with built-in filtration:** Take off the filter support brace and remove the filter pan from the cabinet.
- D. **Decathlon four-battery systems:** Casters are pre-installed on the frying system and the carton is furnished with three unloading ramps. Remove the braces from the front casters by taking out the securing bolts. Carefully roll the unit down the ramps from the front (cooking side).
- E. Remove all plastic skin from sides, front, and doors of the fryer(s). Failure to do this prior to initial fryer operation will make it very difficult to remove later.

# ESG35T

## CHAPTER 1: INSTALLATION INSTRUCTIONS

### 1.4 Pre-Connection Preparation

**⚠ WARNING**  
**If the incoming gas pressure is in excess of ½" PSI (3.45 kPa/35 mbar), a step-down regulator will be required.**

#### NATIONAL CODE REQUIREMENTS:

This equipment is to be installed in compliance with the Basic Plumbing Code of the Building Officials and Code Administrators International, Inc. (BOCA) and the Food Service Sanitation Manual of the U.S. Food and Drug Administration.

This equipment is manufactured to use the type of gas specified on the rating plate attached to the door. Connect equipment stamped "NAT" only to natural gas and that stamped "PRO" only to LP (Propane) gas.

#### Heat Inputs

Nominal Heat Inputs (Qn), Gas Type, Orifice Size, Pressures and Adjustments, Orifice Quantity are listed in the table below:

| MODEL* | NOMINAL HEAT INPUT- Qn (BTU) | GAS TYPE | ORIFICE SIZE (MM) | MANIFOLD GAS PRESSURE (INCH W.C.) | ORIFICE QUANTITY |
|--------|------------------------------|----------|-------------------|-----------------------------------|------------------|
| ESG35T | 70                           | NAT      | 2.18 (#44)        | 3.8                               | 3                |
|        | 67                           | LP       | 1.40(#54)         | 10                                | 3                |

**NOTE:** Outlet gas pressure must be adjusted strictly within the above requirements 5 to 10 minutes after the appliance is operating.

### 1.5 Connection to the Gas Supply Line

**NOTE:** The gas supply (service) line must be the same size or greater than the fryer inlet line. This appliance is equipped with a ½-inch (15-mm) inlet. The gas supply line must be sized to accommodate all gas-fired equipment connected to the line. Consult the local gas company or supplier, or your local contractor for minimum supply line requirements.

**NOTE:** If quick-disconnect supply lines or flex lines are used, increase supply line size to ¾-inch (22-mm) or larger.

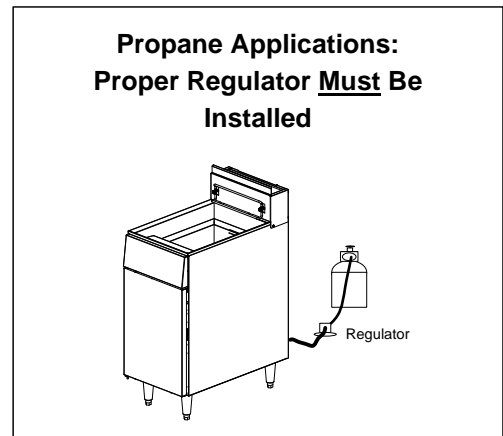

**⚠ DANGER**  
**A manual shut-off valve must be installed in the gas supply (service) line upstream of this appliance and in a position where it can be reached quickly in the event of an emergency.**

**⚠ DANGER**  
**The fryer must be connected to the gas supply specified on the rating and serial number plate located on the inside of the appliance door. DO NOT ATTACH THIS APPLIANCE TO A GAS SUPPLY FOR WHICH IT IS NOT CONFIGURED!**

# ESG35T

## CHAPTER 1: INSTALLATION INSTRUCTIONS

### DANGER

Before connecting new pipe to this appliance, the pipe must be blown out thoroughly to remove all foreign material. Foreign material in the burner and gas valve will cause improper and potentially dangerous operation.

### DANGER

All connections must be sealed with a joint compound suitable for the gas being used and all connections must be tested for leaks using a solution of soapy water before lighting any pilots. Never use matches, candles, or any other ignition source to check for leaks. If gas odors are detected, shut off the gas supply to the appliance at the main shut-off valve and immediately contact the local gas company or an authorized service agency for service.

Adequate means must be provided to limit the movement of fryers without depending upon the gas line connections. If a flexible gas hose is used, a restraining cable must be connected at all times when the fryer is in use. **NOTE: The installation must be inspected after it is complete to ensure it meets the intent of these instructions. The on-site supervisor and/or operator(s) should be informed that the appliance is installed with restraints. If restraints are removed to move fryer (cleaning beneath and behind, relocation, etc.), ensure that they are re-installed when fryer is returned to its permanently installed position.**

### 1.6 Gas Conversion Procedures

### DANGER

This appliance was configured at the factory for a specific type of gas. Converting from one gas type to another requires the installation of specific gas-conversion components.

Switching to a different type of gas without installing the proper conversion components may result in fire or explosion. **NEVER ATTACH THIS APPLIANCE TO A GAS SUPPLY FOR WHICH IT IS NOT CONFIGURED!**

Conversion of this appliance from one type of gas to another should only be performed by qualified, licensed, and authorized installation or service personnel, as defined in Section 1.5 of this manual.

See gas valve illustration below and gas valve, burner and orifice location on page 1-5 when performing the following conversions.

When converting from natural gas to propane (or vice-versa), the following procedures apply:

- ◆ Burner orifices and pilot orifice **MUST** be replaced (see page 1-5 for kit part numbers).
- ◆ Adjust orifice gas pressure by turning the gas-valve adjustment screw (see page 1-2 for gas types and pressures).
- ◆ After adjustment, replace the adjustment-screw cover.
- ◆ Affix the new label included with the conversion kit next the existing rating plate stating that the gas type has been converted. Remove any references to the previously used gas from the existing rating plate.

Conversion from one gas family to another (i.e. changing from natural gas to propane) requires special components. Obtain the necessary components using the table on page 1-6.

**Conversions can only be executed by qualified, factory-authorized personnel.**

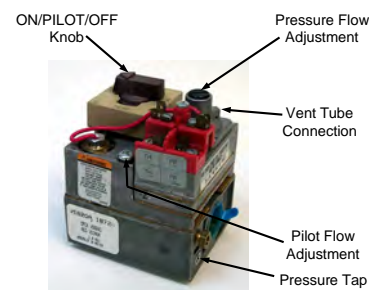

# ESG35T

## CHAPTER 1: INSTALLATION INSTRUCTIONS

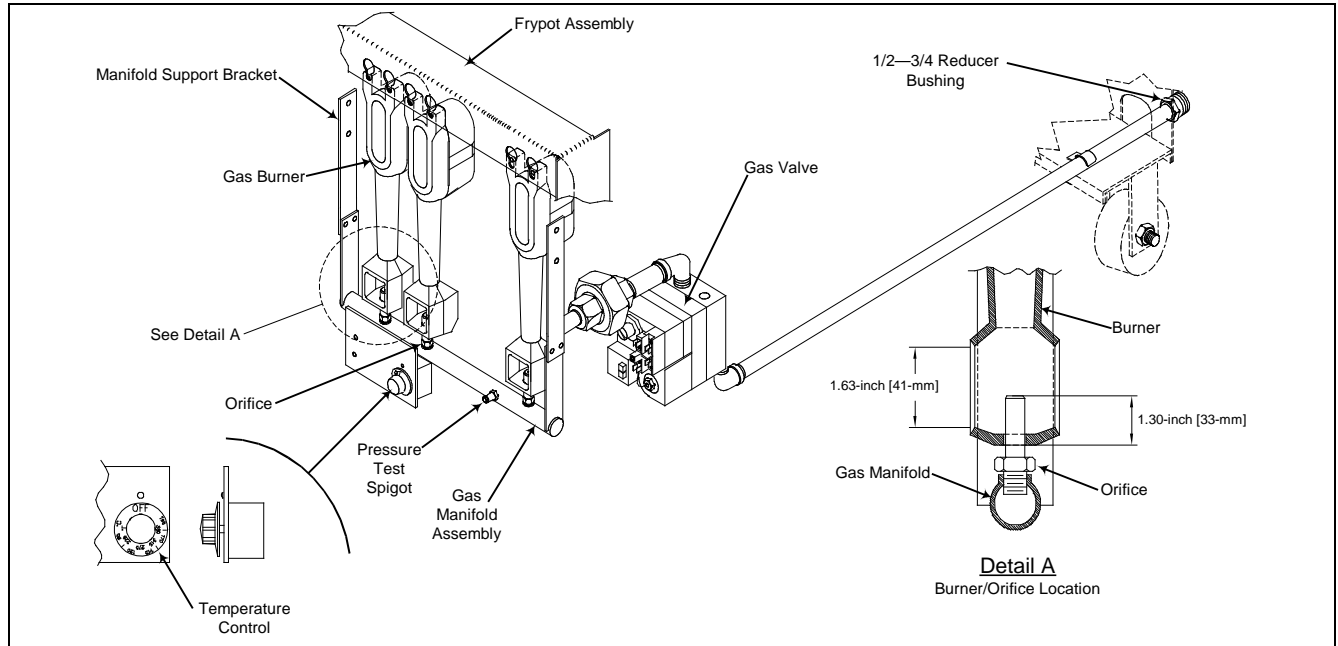

Typical gas valve, burner and orifice locations

### 1.7 Gas Conversion Components

Use the following components to convert from natural gas to propane and vice-versa. See Section 1.5 for orifice quantities required for conversion.

- Natural to Propane: 826-3174
- Propane to Natural: 826-3175

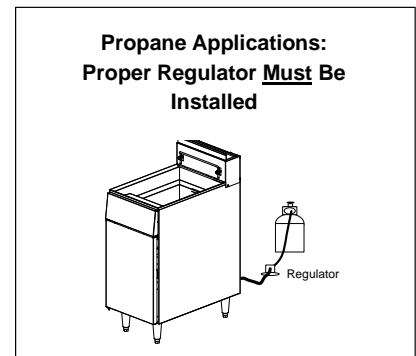



# ESG35T

## CHAPTER 2: OPERATION

---

### 2.1 Initial Startup

Wash the unit and accessories thoroughly with hot, soapy water to remove any film residue, dust or debris. Rinse and wipe dry. Close the drain valve completely. Ensure the operating thermostat and high-limit thermostat sensing bulbs inside the frypot are securely seated in the holding clamp.

#### 2.1.1 Operating the Gas Valve

Rotate the knob counter-clockwise to the ON or PILOT positions. Depress and rotate the knob clockwise to turn the valve OFF.

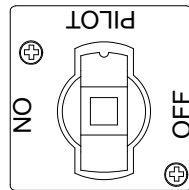

PILOT Position

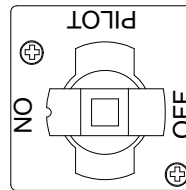

ON Position

#### 2.1.2 Pilot Lighting Procedures

**NOTE:** This fryer was tested, adjusted and calibrated to sea level conditions before leaving the factory. Adjustments may be necessary to meet local conditions, and are to be performed only by qualified service personnel. Adjustments are the responsibilities of the customer or dealer and are not covered by Frymaster warranty.

The pilot is located high in the cabinet center, at the base of the frypot. Use a long match to light the pilot. Perform the following steps in sequence before lighting the pilot:

1. Turn off the manual shut-off valve on the incoming gas supply line.
2. Turn the operating thermostat to the OFF position.
3. Depress and turn the gas valve knob to the OFF position.
4. Wait at least 5 minutes for any accumulated gas to disperse.
5. Fill the frypot with oil, shortening or water to the bottom OIL LEVEL line scribed on the frypot back. Ensure heating tubes are covered in liquid prior to engaging burners.

**NOTE:** If solid shortening is used, pack the shortening into the frypot, ensuring the shortening is packed beneath, between and above the tubes prior to operating fryer.

6. Open the manual shut-off valve on the incoming gas supply line and rotate the gas valve knob to the PILOT position.
7. Push and hold the knob in and apply a lighted match to the pilot burner head. Continue to hold the knob in for about 60 seconds after the flame appears on the pilot. Release the knob. The pilot should remain lit.

**⚠ DANGER**

**If the pilot fails to remain lit, turn the gas valve "OFF" and wait 5 minutes before attempting to re-light.**

# ESG35T

## CHAPTER 2: OPERATION

### 2.1.3 Lighting the Burners



#### WARNING

NEVER set a complete block of solid shortening on top of the heating tubes. To do so will damage the heating tubes and frypot, and void the warranty.

1. Ensure the frypot is filled with oil or shortening to the lower of the two oil level lines embossed on the back wall of the frypot. **NOTE:** If solid shortening is used, pack the shortening into the frypot, ensuring the shortening is packed beneath, between and above the tubes prior to operating fryer.



#### DANGER

"Dry-firing" the fryer will cause damage to the frypot and can cause a fire. Always ensure that shortening, cooking oil or water covers the burner tubes before lighting the burners.

2. With the pilot lit, push down and slowly turn the gas valve knob to the ON position.
3. Rotate the operating thermostat knob to the desired frying temperature. The burner should light and burn with a strong blue flame.



#### DANGER

If the pilot and burners go out, the fryer must be completely shut down at least five minutes before re-lighting.

### 2.2 Shutting the Fryer Down

For temporary shutdown, turn the operating thermostat to the OFF position and cover the frypot. Ensure oil is kept in the frypot if the pilot is lit.

For complete shutdown, turn the operating thermostat to the OFF position, turn the gas valve knob to the OFF position and cover the frypot.

### 2.3 Daily Operation

1. Do not allow grease to accumulate or harden on the frame, body, or flue of the fryer. Clean the fryer inside and out with a solution of detergent and hot water daily.
2. Filter the cooking oil by draining the frypot through a filter cone at least daily. After the oil has been drained from the frypot, remove any residue from the pot, using a non-abrasive scraper if necessary.
3. Clean the frypot at least once each week by filling it to just below the upper oil level mark with water. Add one cup of detergent and bring the solution to a boil. Allow the solution to simmer for 10-15 minutes, then drain and rinse the frypot with clean water twice. Add ¼ cup of white vinegar to the last rinse to neutralize alkalinity remaining from the detergent. Wipe the frypot surfaces with a dry towel before refilling with cooking oil. If the fryer is not to be used immediately after cleaning, wipe the frypot interior with a light coat of cooking oil to prevent rust.

### 2.4 Recommended Spare Parts

| DESCRIPTION               | PART #<br>ESG35T |
|---------------------------|------------------|
| Operating Thermostat      | 826-2013         |
| High-Limit Thermostat     | 807-3516         |
| Thermopile                | 807-3485         |
| Pilot Burner, Natural Gas | 810-2032         |
| Pilot Burner, Propane Gas | 810-2155         |
| Orifice, Natural          | 810-4389         |
| Orifice, Propane          | 810-3529         |
| Gas Valve, Natural        | 807-1603         |
| Gas Valve, Propane        | 807-1604         |
| Leg                       | 810-3168         |
| Caster, 5-inch w/o Brake  | 810-0356         |
| Caster, 5-inch w/Brake    | 810-0357         |

**ESG35T**  
**CHAPTER 2: OPERATION**

**2.5 Wiring Diagram**

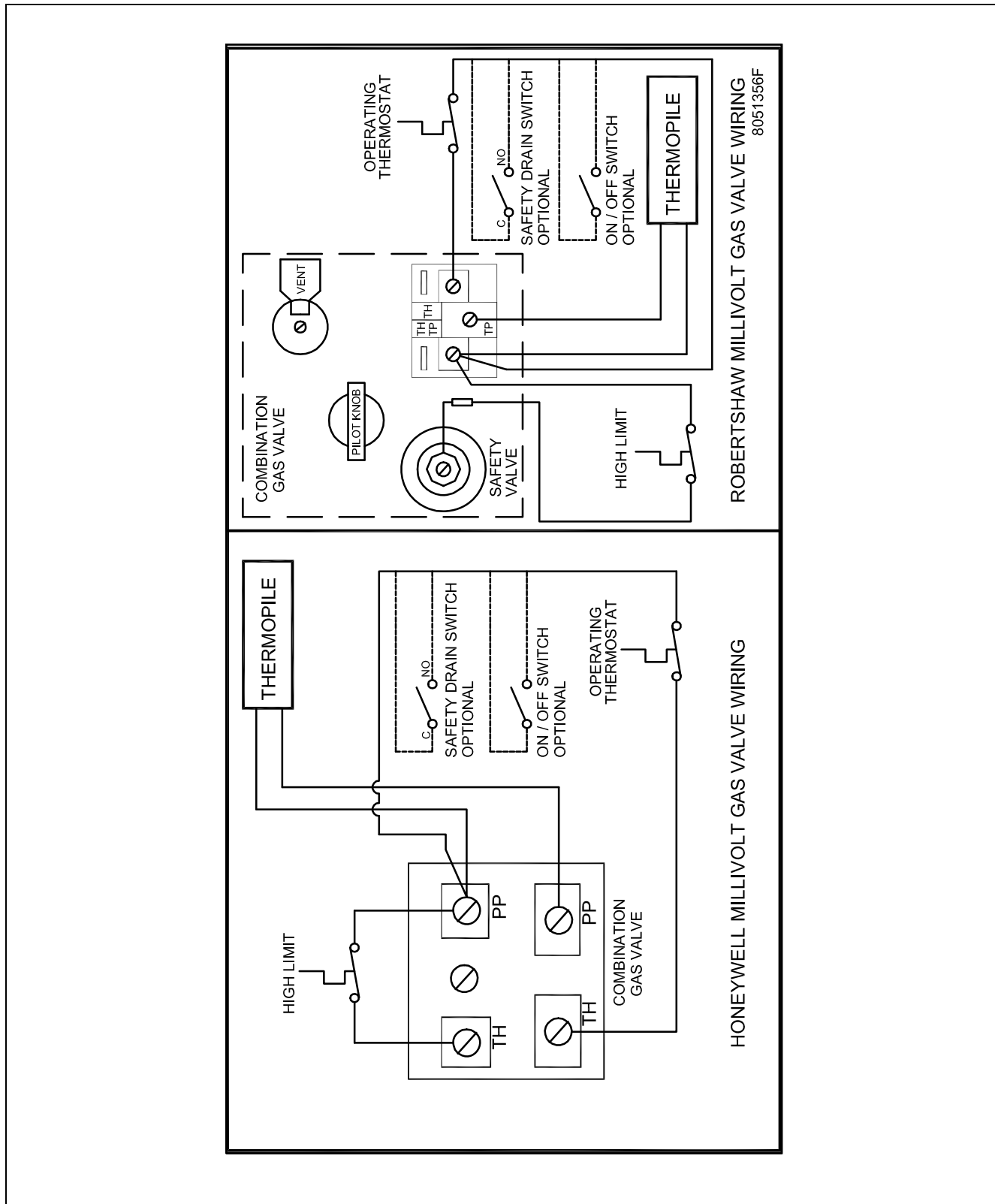



Welbilt (China) Foodservice Co., Ltd  
151 Jianye Road Binjian District  
Hangzhou, Zhenjiang, 310052 China

800-551-8633

318-865-1711

[WWW.FRYMASTER.COM](http://WWW.FRYMASTER.COM)

EMAIL: [FRYSERVICE@FRYMASTER.COM](mailto:FRYSERVICE@FRYMASTER.COM)

©2025 Frymaster LLC. except where explicitly stated otherwise. All rights reserved. Continuing product improvement may necessitate change of specifications without notice.

Part Number FRY\_IOM\_8197680H 02/2025

