



We Fit the Way You Fry™

# FilterQuick™ FQG80T/100T/120T easyTouch® Gas Fryer

## Service Manual

This manual is updated as new information and models are released. Visit our website for the latest manual.



### FOR YOUR SAFETY

**Do Not Store or use gasoline  
or other flammable vapors  
and liquids in the vicinity of  
this or any other appliance.**



8 1 9 7 9 5 5

Part Number: FRY\_SM\_8197955 04/2025

Original Instructions



**WELBILT**  
an Ali Group Company

**NOTICE**

IF, DURING THE WARRANTY PERIOD, THE CUSTOMER USES A PART FOR THIS FRYMASTER EQUIPMENT OTHER THAN AN UNMODIFIED NEW OR RECYCLED PART PURCHASED DIRECTLY FROM FRYMASTER, OR ANY OF ITS FACTORY AUTHORIZED SERVICERS, AND/OR THE PART BEING USED IS MODIFIED FROM ITS ORIGINAL CONFIGURATION, THIS WARRANTY WILL BE VOID. FURTHER, FRYMASTER AND ITS AFFILIATES WILL NOT BE LIABLE FOR ANY CLAIMS, DAMAGES OR EXPENSES INCURRED BY THE CUSTOMER WHICH ARISE DIRECTLY OR INDIRECTLY, IN WHOLE OR IN PART, DUE TO THE INSTALLATION OF ANY MODIFIED PART AND/OR PART RECEIVED FROM AN UNAUTHORIZED SERVICER.

**NOTICE**

This appliance is intended for professional use only and is to be operated by qualified personnel only. A Frymaster Authorized Servicer (FAS) or other qualified professional should perform installation, maintenance, and repairs. Installation, maintenance, or repairs by unqualified personnel may void the manufacturer's warranty. See Chapter 1 of the Installation and Operation manual for definitions of qualified personnel.

** WARNING**

After installation of a gas fryer and after any maintenance to the gas system of a gas fryer-manifold, valve, burners, etc. - check for gas leaks at all connections. Apply a thick soapy solution to all connections and ensure there are no bubbles. There should be no smell of gas.

** DANGER**

Improper installation, adjustment, maintenance or service, and unauthorized alterations or modifications can cause property damage, injury, or death. Read the installation, operating, and service instructions thoroughly before installing or servicing this equipment.

** DANGER**

Adequate means must be provided to limit the movement of this appliance without depending upon the gas line connection. All fryers equipped with casters must be stabilized by installing restraining chains. If a flexible gas line is used, an additional restraining cable must be connected at all times when the fryer is in use.

** DANGER**

The front ledge of this appliance is not a step! Do not stand on the appliance. Serious injury can result from slips or contact with the hot oil.

** DANGER**

Do not store or use gasoline or other flammable liquids or vapors in the vicinity of this or any other appliance.

** WARNING**

Use caution and wear appropriate safety equipment to avoid contact with hot oil or surfaces that may cause severe burns or injury.

** DANGER**

Keep all items out of drains. Closing actuators may cause damage or injury.

**FQ80T/100T/120T easyTouch® FILTERQUICK™ SERIES GAS FRYERS**  
**SERVICE MANUAL**  
**TABLE OF CONTENTS**

---

**Chapter 1: Service Procedures**

1.1	FQ4000-80T/100T/120T Menu Summary Trees .....	1-1
1.1.1	FQ4000-80T/100T/120T Menu Tree Popeye's .....	1-1
1.1.2	FQ4000-80T/100T/120T Information Statistics Menu Tree Popeye's.....	1-2
1.1.3	FQ4000-80T/100T/120T Menu Tree Raising Canes .....	1-3
1.1.4	FQ4000-80T/100T/120T Information Statistics Menu Tree Raising Canes.....	1-4
1.2	FQ4000 Password Codes.....	1-5
1.3	Service Required Errors.....	1-5
1.4	Error Log Codes .....	1-5
1.5	Component Check.....	1-7
1.6	Reading the Model Numbers.....	1-8
1.7	Functional Description.....	1-8
1.8	Ignition System .....	1-8
1.9	Thermostats .....	1-9
1.10	Smart Interface Board (SIB).....	1-10
1.10.1	Current Flow Through the SIB Board.....	1-11
1.10.2	Frequently Used Test Points for SIB.....	1-12
1.10.3	SIB (Smart Interface Board) Troubleshooting.....	1-12
1.10.4	SIB (Smart Interface Board) Pin Positions and Harnesses.....	1-13
1.11	Accessing Fryers for Servicing.....	1-14
1.12	Cleaning the Gas Valve Vent Tube.....	1-14
1.13	Checking the Burner Manifold Gas Pressure.....	1-14
1.14	Adjusting the Pilot Flame.....	1-16
1.15	Replacing Fryer Components.....	1-16
1.15.1	Replacing the Controller .....	1-16
1.15.2	Replacing the SIB, FIB, Time Delay Relay Board, KCCM Board or Ignition Module	1-16
1.15.3	Overview of Vat Components .....	1-17
1.15.4	Replacing the Temperature Probe .....	1-17
1.15.5	Replacing the High-Limit Probe .....	1-18
1.15.6	Replacing the Float Switch.....	1-18
1.15.7	Replacing the ATO Probe.....	1-19
1.15.8	Replacing the VIB (AIF) Probe.....	1-20
1.15.9	Replacing a Gas Valve .....	1-20
1.15.10	Replacing a Pilot Assembly or Trailing Pilot Assembly .....	1-21
1.15.11	Adjusting the Ignitor Assembly.....	1-21
1.15.12	Replacing the Filter Motor or Filter Pump.....	1-21
1.15.13	Replacing the Frypot .....	1-22
1.15.14	Replacing Transformers/Pump Relay/Reset Switch Relay/Power Supply/Frypot...	1-23
1.16	Troubleshooting and Problem Isolation .....	1-23
1.16.1	Heating (Ignition) Failure .....	1-24
1.16.2	Improper Burner Function .....	1-25
1.16.3	Improper Temperature Control .....	1-26
1.16.4	Controller Malfunctions.....	1-26
1.16.5	Filtration Malfunctions.....	1-26
1.16.6	Leakage.....	1-27
1.17	Troubleshooting Guides .....	1-28

1.17.1	Troubleshooting the 24 VAC Circuit.....	1-28
1.17.2	Troubleshooting the Gas Valve .....	1-29
1.17.3	Troubleshooting the Temperature Probe.....	1-29
1.17.4	Replacing the Reset Switch Relay.....	1-29
1.18	Probe Resistance Chart .....	1-30
1.19	Manual Top-Off and Filtration Service Procedures .....	1-30
1.19.1	FIB Troubleshooting.....	1-30
1.19.2	Filtration Troubleshooting .....	1-32
1.19.3	FIB (Filter Interface Board) Filtration Top-off Pin Positions and Harnesses .....	1-33
1.19.4	Replacing FIB Board, Power Supply, Filter Relay or Transformer .....	1-34
1.19.4.1	FIB (Filter Interface Board) LED's and Test Points .....	1-34
1.20	FIB (Filter Interface Board) Service Procedures.....	1-35
1.20.1	Manually Draining, Refilling or Filtering using the Manual Filtration Mode .....	1-35
1.20.2	Control Power Reset Switch.....	1-35
1.22	VIB (Valve Interface Board) Service Procedures.....	1-35
1.22.1	VIB (Valve Interface Board) Troubleshooting .....	1-36
1.22.2	VIB (Valve Interface Board) Pin Positions and Harnesses.....	1-37
1.22.3	Replacing a VIB (Valve Interface Board) Board.....	1-38
1.22.4	Replacing a Rotary Actuator.....	1-38
1.22.5	Float Switch .....	1-38
1.22.5.1	Float Switch Troubleshooting .....	1-39
1.22.5.2	Float Switch Time Delay Relay Wiring Diagram .....	1-39
1.23	FQ4000 Controller Service Procedures .....	1-40
1.23.1	FQ4000 Controller Troubleshooting .....	1-40
1.23.1.1	FQ4000 Controller Functional Troubleshooting.....	1-42
1.24	Loading and Updating Software/Menu Procedures.....	1-43
1.25	Software/Menu Update Troubleshooting .....	1-45
1.26	Wiring Diagrams .....	1-46
1.27	High Limit Test.....	1-49

# FQ80T/100T/120T easyTouch® SERIES FILTERQUICK GAS FRYERS

## CHAPTER 1: SERVICE PROCEDURES

### 1.1 FQ4000 80T/100T/120T easyTouch® Menu Summary Trees

#### 1.1.1 FQ4000-80T/100T/120T easyTouch® Menu Tree Popeye's

Reflected below are the major programming sections in the FQ4000 easyTouch® and the order in which the headings will be found in the controller.

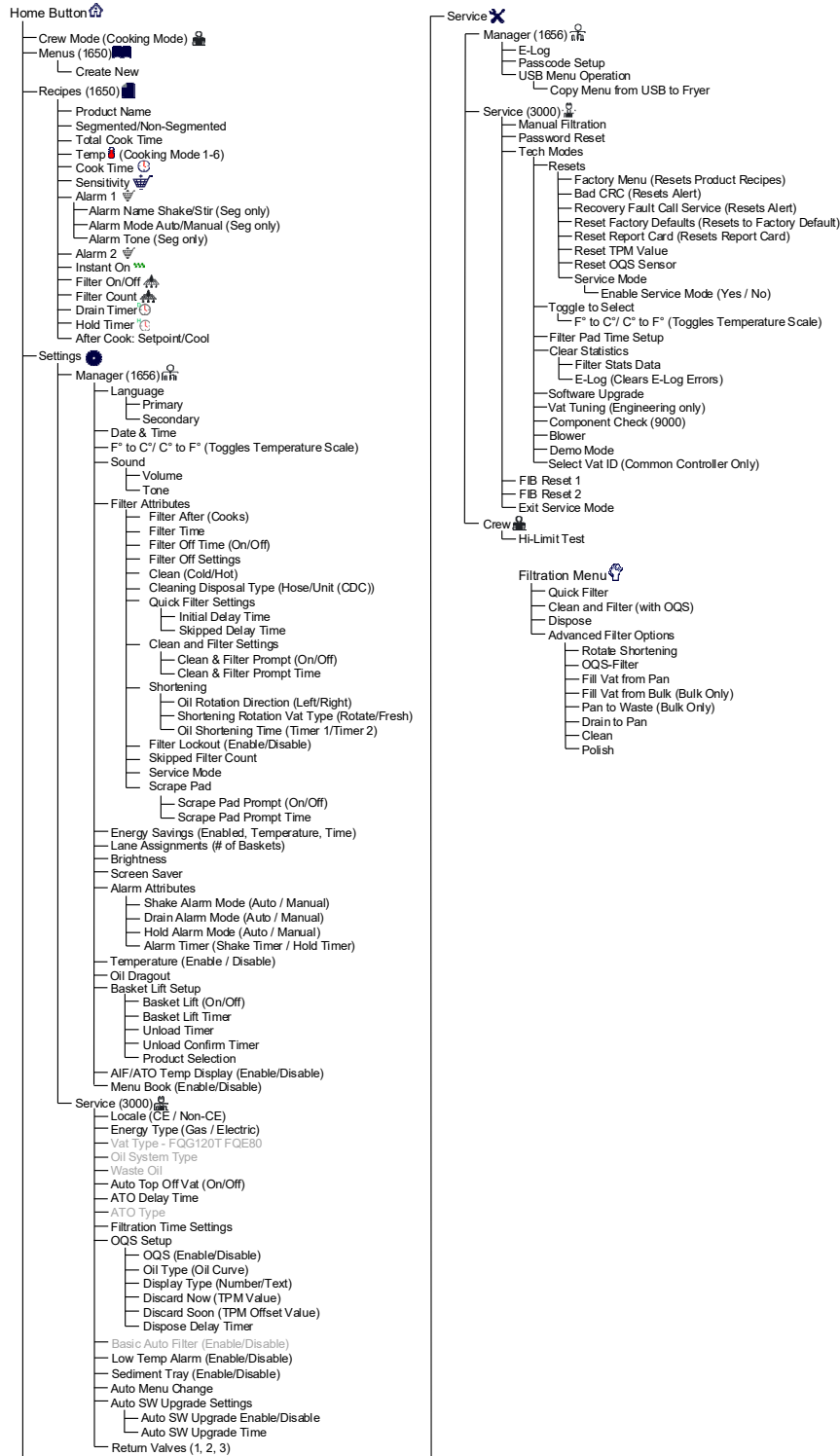

## 1.1.2 FQ4000-80T/100T/120T Information Statistics Menu Tree Popeye's

Reflected below are the information statistics in the FQ4000 and the order in which the headings will be found in the controller.

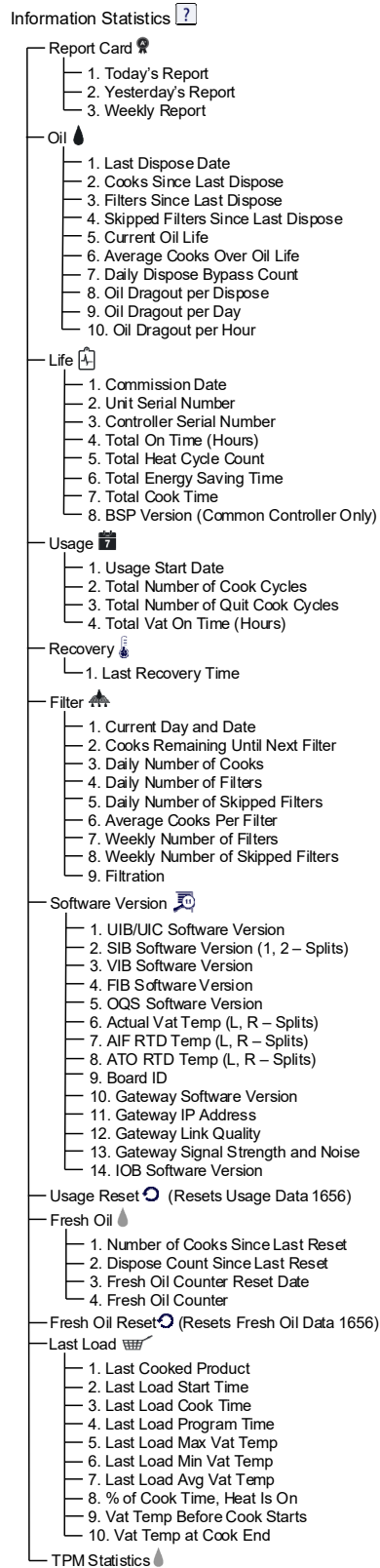

### 1.1.3 FQ4000 Menu Tree - Raising Canes



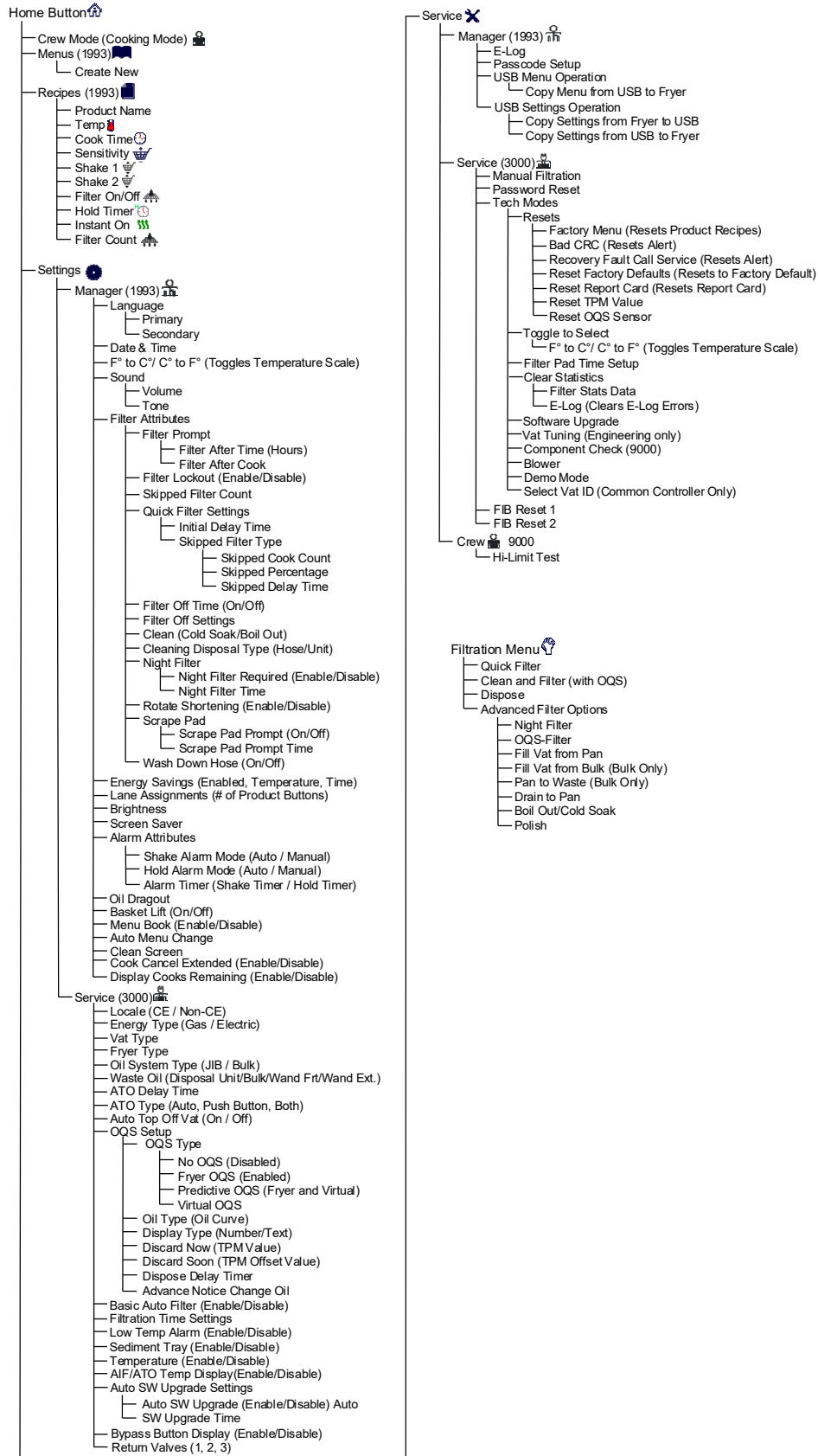











Reflected below are the major programming sections in the FQ4000 and the order in which the headings will be found in the controller.



### 1.1.4 FQ4000 Information Statistics Menu Tree General Market, Raising Canes

Reflected below are the information statistics in the FQ4000 and the order in which the headings will be found in the controller.

Information Statistics 

- Daily Stats 
  - 1. Filters/Skipped Filters/Cooks Today's
- Report Card 
  - 1. Today's Report
  - 2. Yesterday's Report
  - 3. Weekly Report
- Oil 
  - 1. Last Dispose Date
  - 2. Cooks Since Last Dispose
  - 3. Filters Since Last Dispose
  - 4. Skipped Filters Since Last Dispose
  - 5. Current Oil Life
  - 6. Average Cooks Over Oil Life
  - 7. Daily Dispose Bypass Count
  - 8. Oil Dragout per Dispose
  - 9. Oil Dragout per Day
  - 10. Oil Dragout per Hour
- TPM Statistics 
- Filter 
  - 1. Current Day and Date
  - 2. Cooks Remaining Until Next Filter
  - 3. Daily Number of Cooks
  - 4. Daily Number of Filters
  - 5. Daily Number of Skipped Filters
  - 6. Average Cooks Per Filter
  - 7. Weekly Number of Filters
  - 8. Weekly Number of Skipped Filters
  - 9. Filtration
- Filter Reset  (Resets Filter Stats Data 4321)
- Fresh Oil 
  - 1. Number of Cooks Since Last Dispose
  - 2. Dispose Count Since Last Reset
  - 3. Fresh Oil Counter Reset Date
  - 4. Fresh Oil Counter
- Fresh Oil Reset  (Resets Fresh Oil Data 4321)
- Software Version 
  - 1. UIB/UIC Software Version
  - 2. SIB Software Version (1, 2 – Splits)
  - 3. VIB Software Version
  - 4. FIB Software Version
  - 5. OQS Software Version
  - 6. Actual Vat Temp (L, R – Splits)
  - 7. AIF RTD Temp (L, R – Splits)
  - 8. ATO RTD Temp (L, R – Splits)
  - 9. Board ID
  - 10. Gateway Software Version
  - 11. Gateway IP Address
  - 12. Gateway Link Quality
  - 13. Gateway Signal Strength and Noise
  - 14. IOB Software Version
- Recovery 
  - 1. Last Recovery Time
- Usage 
  - 1. Usage Start Date
  - 2. Total Number of Cook Cycles
  - 3. Total Number of Quit Cook Cycles
  - 4. Total Vat On Time (Hours)
- Usage Reset  (Resets Usage Data 4321)
- Life 
  - 1. Commission Date
  - 2. Unit Serial Number
  - 3. Controller Serial Number
  - 4. Total On Time (Hours)
  - 5. Total Heat Cycle Count
  - 6. Total Energy Saving Time
  - 7. Total Cook Time
  - 8. BSP Version (Common Controller Only)
- Last Load 
  - 1. Last Cooked Product
  - 2. Last Load Start Time
  - 3. Last Load Cook Time
  - 4. Last Load Program Time
  - 5. Last Load Max Vat Temp
  - 6. Last Load Min Vat Temp
  - 7. Last Load Avg Vat Temp
  - 8. % of Cook Time, Heat Is On
  - 9. Vat Temp Before Cook Starts
  - 10. Vat Temp at Cook End



## 1.2 FQ4000 Password Codes

Press the HOME button to enter MENUS, RECIPES, SETTINGS or SERVICE menus.

- **1650 – MENUS, RECIPES,**
- **1656 – SETTINGS (MANAGER), SERVICE (MANAGER)**
- **3000 – SETTINGS (SERVICE), SERVICE (SERVICE) Enter Tech Mode**
- **9000 – Component Check [SETTINGS (SERVICE), SERVICE (SERVICE) Enter Tech Mode] [SETTINGS (SERVICE)], High Limit Test [CREW]**
- **1993 – Raising Canes**

The following code is entered when prompted to do so.

- **1111 – Reset SERVICE REQUIRED Message** – Enter when the issue is fixed and prompted to enter code.

## 1.3 Service Required Errors

A **SERVICE REQUIRED** error with a description of the error displays on the controller. After **YES** is pressed the alarm is silenced. The controller displays an error message from the list below three times with the location of the error. Then the controller displays **SYSTEM ERROR FIXED? YES/NO**. If yes is chosen, **enter code 1111**. If NO is chosen, the system returns to cook mode if possible, for 15 minutes, then redisplay error until issue is fixed.

## 1.4 Error Log Codes

To access the error log, press the home button. Press the service button. Press the manager button. Enter 1656 and press the check button. Press the E-log button. The ten most recent errors are listed from top to bottom, with the top error being the most recent error. A "G" indicates a global error such as a filtration error. Side specific errors in split vats are indicated by L for left or R for right. Pressing the left down arrow allows scrolling through the errors. If no errors are present the screen will be blank.

Code	ERROR MESSAGE	EXPLANATION
<b>E13</b>	TEMPERATURE PROBE FAILURE	TEMP Probe reading out of range
<b>E16</b>	HIGH LIMIT 1 EXCEEDED	High limit temperature is past more than 410°F (210°C), or in CE countries, 395°F (202°C)
<b>E17</b>	HIGH LIMIT 2 EXCEEDED	High limit switch has opened.
<b>E18</b>	HIGH LIMIT PROBLEM DISCONNECT POWER	Vat temperature exceeds 460°F (238°C) and the high limit has failed to open. Immediately disconnect power to the fryer and call service.
<b>E19</b>	HEATING FAILURE – XXX F or XXX C	Heating Control latch circuit failed. Heat Contactor failed to latch.
<b>E25</b>	HEATING FAILURE - BLOWER	The air pressure switch(s) failed to close.
<b>E27</b>	HEATING FAILURE - PRESSURE SWITCH - CALL SERVICE	The air pressure switch has failed closed.
<b>E28</b>	HEATING FAILURE – XXX F or XXX C	The fryer has failed to ignite and has locked out the ignition module.
<b>E29</b>	TOP OFF PROBE FAILURE - CALL SERVICE	ATO RTD reading out of range
<b>E32</b>	DRAIN VALVE NOT OPEN - FILTRATION AND TOP OFF DISABLED - CALL SERVICE	Drain valve was trying to open and confirmation is missing
<b>E33</b>	DRAIN VALVE NOT CLOSED - FILTRATION AND TOP OFF DISABLED - CALL SERVICE	Drain valve was trying to close and confirmation is missing
<b>E34</b>	RETURN VALVE NOT OPEN - FILTRATION AND TOP OFF DISABLED - CALL SERVICE or RIGHT VALVE NOT OPEN for multi- return valve systems.	Return valve or Right valve (multi-return valve systems) was trying to open and confirmation is missing
<b>E35</b>	RETURN VALVE NOT CLOSED - FILTRATION AND TOP OFF DISABLED - CALL SERVICE or RIGHT VALVE NOT CLOSED for multi- return valve systems.	Return valve or Right valve (multi-return valve systems) was trying to close and confirmation is missing
<b>E36</b>	VALVE INTERFACE BOARD FAILURE - FILTRATION AND TOP OFF DISABLED - CALL SERVICE	Valve Interface Board connections lost or board failure.
<b>E37</b>	AUTOMATIC INTERMITTENT FILTRATION PROBE FAILURE - FILTRATION DISABLED - CALL SERVICE	AIF (VIB Probe) RTD reading out of range.
<b>E39</b>	CHANGE FILTER PAD	25-hour timer has expired, or dirty filter logic has activated.
<b>E41</b>	OIL IN PAN ERROR	The system detects that oil may be present in the filter pan.
<b>E42</b>	CLOGGED DRAIN (Gas)	Vat did not empty during filtration
<b>E43</b>	OIL SENSOR FAILURE - CALL SERVICE	Oil level sensor may have failed.
<b>E44</b>	RECOVERY FAULT	Recovery time exceeded maximum time limit.
<b>E45</b>	RECOVERY FAULT – CALL SERVICE	Recovery time exceeded maximum time limit for two or more cycles. Reset the error code by going to: HOME -> SERVICE

Code	ERROR MESSAGE	EXPLANATION
		-> SERVICE ->3000-> TECH MODE -> RESETS -> RECOVERY FAULT CALL SERVICE -> YES.
E46	SYSTEM INTERFACE BOARD 1 MISSING - CALL SERVICE	SIB board 1 connection lost or board failure.
E51	DUPLICATE BOARD ID - CALL SERVICE	Two or more controllers have the same location ID.
E52	USER INTERFACE CONTROLLER ERROR - CALL SERVICE	The controller has an unknown error.
E53	CAN BUS ERROR - CALL SERVICE	Communications are lost between boards.
E55	SYSTEM INTERFACE BOARD 2 MISSING - CALL SERVICE	SIB board 2 connection lost or board failure.
E56	FLOAT SWITCH STUCK ERROR	Clean the float switch, ensuring it moves freely up and down.
E61	MISCONFIGURED ENERGY TYPE	The fryer is configured for the incorrect energy type.
E62	SLOW HEATING FAILURE XXXF OR XXXC - CHECK ENERGY SOURCE - CALL SERVICE	The vat is not heating properly.
E63	RATE OF RISE	Rate of rise error occurred during a recovery test.
E64	FILTRATION INTERFACE BOARD FAILURE - FILTRATION AND TOP OFF DISABLED - CALL SERVICE	Filtration Interface Board connections lost or board failure.
E65	E65	<p>The float switch does not detect oil.</p> <ol style="list-style-type: none"> <li>1. Ensure the frypot is full of oil.</li> <li>2. Float switch may be stuck up or down.</li> <li>3. Clean the float switch.</li> </ol> <p>Ensure when removing the float switch that its position is clearly marked and replaced properly. Installing the float upside down will change the switch from N/O to N/C. This could allow the empty frypot to ignite. Ensure the float switch moves freely up and down.</p>
E66	DRAIN VALVE OPEN – XXXF OR XXXC	Drain valve is opened during cooking.
E67	SYSTEM INTERFACE BOARD NOT CONFIGURED - CALL SERVICE	Controller is turned on when the SIB board is not configured.
E68	FUSE TRIPPED – CALL SERVICE	The VIB board fuse has tripped and didn't reset.
E69	RECIPES NOT AVAILABLE	The controller has not been programmed with product recipes. Replace controller with factory programmed controller.
E70	OQS TEMP HIGH	Oil temperature is too high for a valid OQS reading. Filter at a temperature between 300°F (149°C) and 375°F (191°C).
E71	OQS TEMP LOW	Oil temperature is too low for a valid OQS reading. Filter at a temperature between 300°F (149°C) and 375°F (191°C).
E72	TPM RANGE LOW	The TPM is too low for a valid OQS reading. This may also be seen with fresh new oil. The incorrect oil type may be selected in the setup menu. The sensor may not be calibrated for the oil type. See oil type chart in instruction document 8197316. If issue continues contact an FAS.
E73	TPM RANGE HIGH	The TPM reading is too high for a valid OQS reading. Dispose the oil.
E74	OQS ERROR	The OQS has an internal error. If issue continues contact an FAS.
E75	OQS AIR ERROR	The OQS is detecting air in the oil. Check the O-rings and check/tighten prescreen filter to ensure no air is entering the OQS sensor. If issue continues contact an FAS.
E76	OQS ERROR	The OQS sensor has a communication error. Check connections to the OQS sensor. Power cycle the entire fryer battery. If issue continues contact an FAS.
E82	LOW OIL DETECTED	This is only visible in the cloud. It's not visible on the UI. The vat doesn't have enough oil to cover the AIF/ATO probes. Fill the vat with oil.
E83	TOP OFF EMPTY	This is only visible in the cloud. It's not visible on the UI. The JIB is out of oil. Replace the JIB and top off the vat.
E85	LEFT RETURN VALVE or LEFT VALVE NOT OPEN VALVE NOT OPE - FILTRATION AND TOP OFF DISABLED - CALL SERVICE	Left return valve was trying to open, and confirmation is missing
E86	LEFT RETURN VALVE or LEFT VALVE NOT CLOSED - FILTRATION AND TOP OFF DISABLED - CALL SERVICE	Left Return valve was trying to close, and confirmation is missing

Code	ERROR MESSAGE	EXPLANATION
E87	RIGHT RETURN VALVE or CENTRAL VALVE NOT OPEN - FILTRATION AND TOP OFF DISABLED - CALL SERVICE	Right return valve or Central Valve was trying to open, and confirmation is missing
E88	RIGHT RETURN VALVE or CENTRAL VALVE NOT CLOSED - FILTRATION AND TOP OFF DISABLED - CALL SERVICE	Right return valve or Central Valve was trying to close, and confirmation is missing

### 1.5 Component Check

The FQ4000-120 controller has a function to check the major components and their status.

With the controller soft powered OFF, press the HOME button. Select Service, Service, Enter 9000, Select Tech Modes, scroll down and select Component Check.

The component name is above each button. The status of the component is below the function. Pressing the button will change the status of the function to what is stated on the button. If the button is shaded that function is not available unless that function is enabled (such as bulk). The JIB reset button and Waste Tank full only displays the status of the switch.

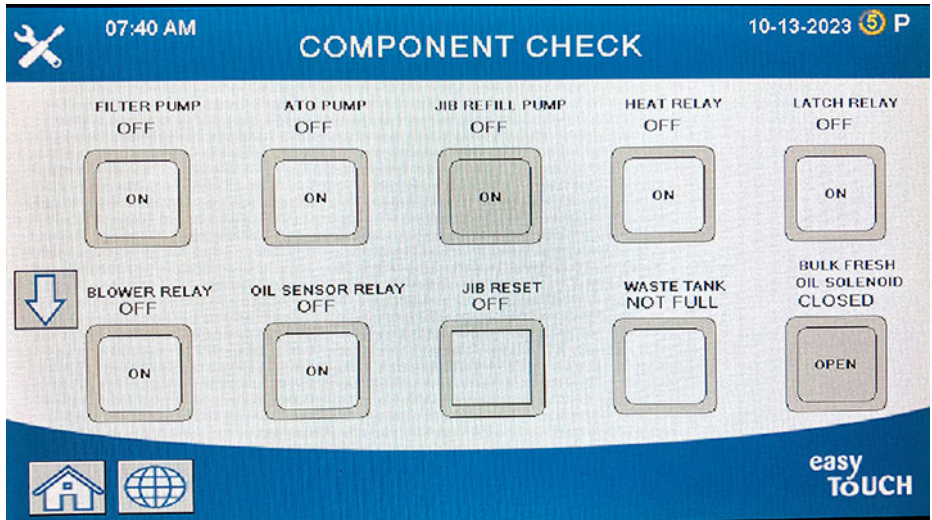

Pressing the home button to exit the function will display driving valves to ensure all valves return to home state. Once completed the controller will display FILL VAT FROM DRAIN PAN? YES NO. Press YES to ensure that any oil in the filter pan is returned to the vat.

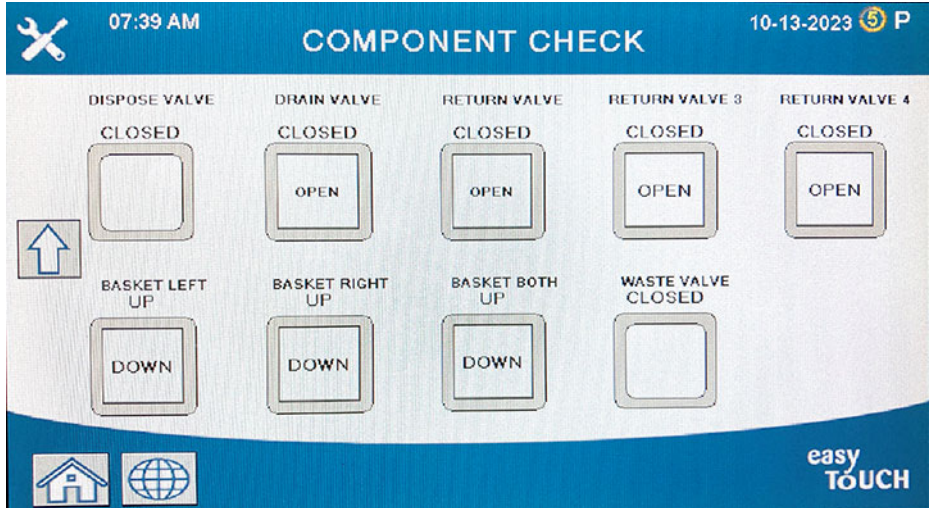



At start-up, the power switch on the touchscreen controller is placed in the ON position, supplying approximately 24 VAC to the heat-control circuitry in the Smart Interface Board and to one side of the heat relay coils on the Smart Interface Board. If the resistance in the temperature probe indicates the temperature in the frypot is below 180°F (82°C), the melt cycle function is activated where a timer activates for six seconds and deactivates for 24 seconds. If the temperature is 180°F (82°C) or above, the melt cycle is bypassed. In either case, ground is supplied to the other leg of the heat relay coils, which closes electronic switches in the 24 VAC circuit to provide current to the ignition module. Circuitry in the ignition module sends 24 VAC current to the gas valve via a normally closed high-limit switch and a float safety switch. Simultaneously, the module causes the ignitor to spark for up to 90 seconds to light the pilot flame. A flame sensor verifies that the pilot is lit by measuring the flow of microamps through the flame. If the pilot does not light (or is extinguished), current to the ignition module is interrupted, preventing the main valve from opening, and the ignition module "locks out" until the power switch is turned OFF, then back ON. A probe monitors the temperature in the frypot. When the programmed setpoint temperature is reached, resistance in the probe causes the heat cycle circuitry in the SIB board to cut off current flow through the heat relay. This in turn cuts off the 24 VAC to the ignition module, causing the gas valve to close.

**NOTE:** Microamp readings on these black modules will move up and down as the module pulses on and off and this is an indication that the module is functioning.

## 1.9 Thermostats

A temperature probe monitors the temperature in the frypot. The probe resistance varies directly with the temperature. As the temperature rises, resistance increases at a rate of approximately 2 ohms for every 1°F (approximately 3.7 ohms for every 1°C). When the programmed setpoint temperature is reached, resistance in the probe causes the heat cycle circuitry in the controller to interrupt current flow through the heat relay. This in turn interrupts the 24 VAC current to the ignition module, resulting in closure of the gas valve.

Circuitry in the controller monitors the probe resistance and controls burner firing when the resistance exceeds or falls below the programmed temperature or setpoint.

The fryers are also equipped with a *high-limit thermostat*. If the fryer fails to properly control the oil temperature, the high-limit thermostat prevents the fryer from overheating to the flash point. The high-limit thermostat acts as a normally closed power switch that opens when exposed to temperatures above 425°F to 450°F (218°C to 232°C).

### 1.10 Smart Interface Board (SIB)

All fryers in this series have a smart interface board (SIB) located in the component box behind the controller panel. The SIB board provides a link between the controller and the fryer's individual components without requiring excessive wiring and executes commands from one central point.

K2 is a single-pole-double throw (SPDT) relay that supplies 24VAC to the ignition and gas valve circuits. The relays on this board are soldered to the board. If a relay fails, the board must be replaced. K1 is a single-pole-double throw (SPDT) relay that supplies voltage through the high limit and the optional air pressure switch.

The SIB LEDs (labeled LED1 through LED7) are arrayed around the board to assist in troubleshooting.

SMART INTERFACE BOARD LED DIAGNOSTIC LIGHTS	
LED 1	24VAC Heat Relay
LED 2	12VDC to Controller
LED 3	24VAC Latch Relay
LED 4	5VDC to probes and switches
LED 6	3.3VDC to Micro Processor
LED 7	Communication to/from Micro Processor

12VDC should be lit and bright at all times. If LED is dim then something is pulling voltage down. Short to ground on 12VDC circuit will cause dim LED.

5VDC should be lit and bright at all times. If LED is dim then something is pulling voltage down. Short to ground on 5VDC circuit will cause dim LED.

When UI is soft powered on this Latch Relay LED will come on first confirming high limit is closed. The blower will then come on and prove the air switch. The relay is a true latch circuit and when broken or turned off the heat relay will also turn off.

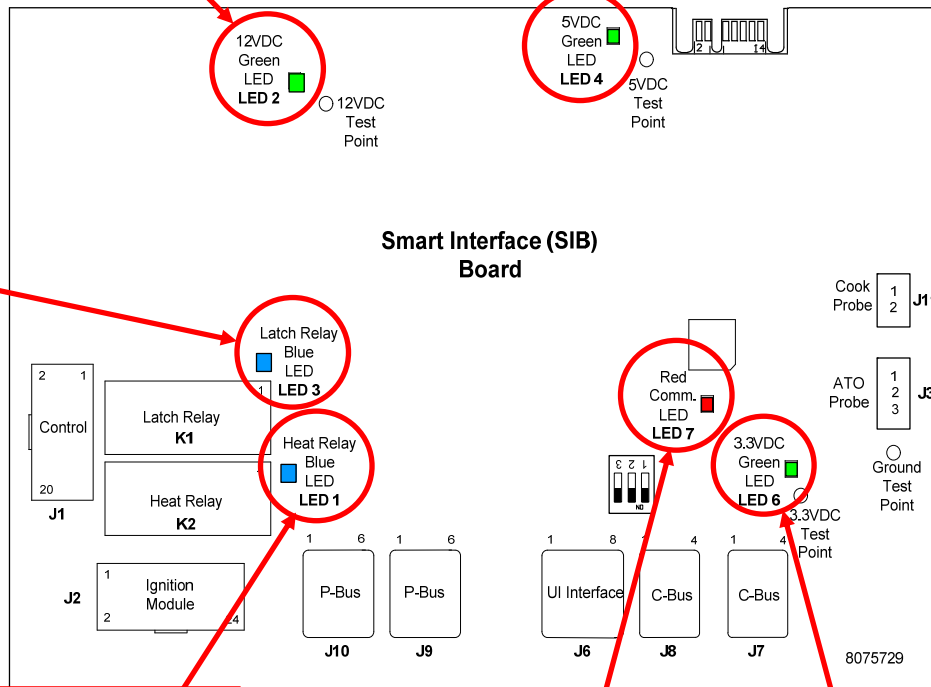

When UI calls for HEAT this LED will come on with the heat relay only after latch relay has been latched in and AIR switch has been proven. This LED will cycle with the call for heat.

Blinking red LED, (Heartbeat). This LED should be blinking and bright at all times when board is powered. The other green LED's being dim or off will cause this LED to be off.

3.3VDC LED should be lit and bright at all times. If dim, then something is pulling voltage down. Short to ground on 3.3VDC circuit will cause dim LED.

**NOTE: Refer to Section 1.17.1 for troubleshooting flowchart.**

The chart on pages 1-9 illustrates current flow through the board, and the table at the top of page 1-10 identifies frequently used test points.

### 1.10.1 Current Flow Through the SIB board

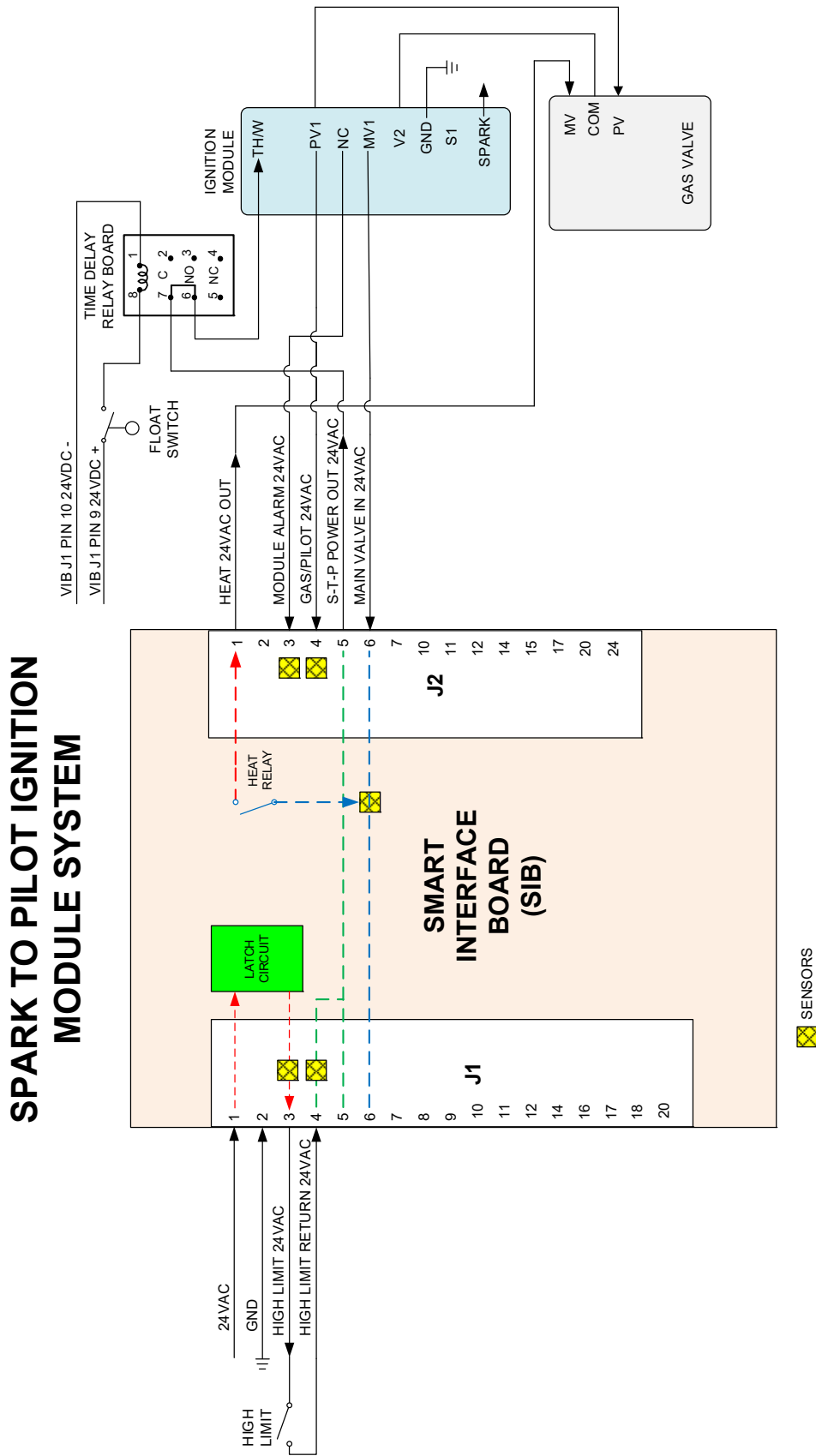

### 1.10.2 Frequently Used Test Points for SIB (Smart Interface Board)

**NOTE: DO NOT CHECK WITH HARNESES UNPLUGGED AS SHORTING THE PINS MAY OCCUR WHICH WILL DAMAGE THE BOARD.**

FREQUENTLY USED TEST POINTS FOR INTERFACE BOARD 1085980			
Test	Meter Setting	Pins	Results
24VAC Power to SIB	50VAC Scale	1 on J1 and GROUND	22-28
12VDC Power to Controller	50VDC Scale	7 and 8 on J6	12-18
24VAC Power to Module	50VAC Scale	5 on J2 and GROUND	22-28
24VAC Power to High-Limit	50VAC Scale	3 on J1 and GROUND	22-28
Probe Resistance	R x 1000 OHMS	Disconnect and test across probe leads	**
Probe Isolation	R x 1000 OHMS	2 on Probe Connector and GROUND	***
High-Limit Continuity	R x 1 OHM	3 on J1 and 4 on J1	0
** See Probe Resistance Chart in section 1.18.			
*** 5 mega-Ohms or greater.			

### 1.10.3 SIB (Smart Interface Board) Troubleshooting

Problem	Probable Causes	Corrective Action
<b>No power to SIB board</b>	A. J1 connection unplugged B. Fuse blown. C. Transformer malfunction	A. Check to ensure J1 on front of SIB board is fully locked into connector. B. Ensure fuse located at the bottom of the control box is not blown and cap is securely tightened. C. Check that proper voltage is present at transformer. See table in section 1.10.4.
<b>SIB BOARD 1 MISSING displayed on the controller.</b>	Loose wire connection.	Ensure the connector from the touch screen is securely attached to plug J6 on the SIB board.
<b>SIB NOT CONFIGURED displayed on the controller.</b>	SIB board not configured	Replace the SIB board.
<b>Green LED's on SIB board are blinking or dim.</b>	Damaged harness between J2 on the VIB board to J9 on the SIB board.	Inspect for heat damage and routing of harness close to the frypot. If damaged replace harness (8075555).



### 1.10.4 SIB (Smart Interface Board) Pin Positions and Harnesses

**NOTE: DO NOT CHECK WITH HARNESSES UNPLUGGED (except ATO and Temp Probes) AS SHORTING THE PINS MAY OCCUR WHICH WILL DAMAGE THE BOARD.**

Connector	From/To	Harness #	Pin #	Function	Voltage	Wire Color
J1	From Transformer	8076449	1	24VAC Input	24VAC	Orange
			2	Ground -		Blue
	To High Limit		3	24VAC Out	24VAC	Orange
	From High Limit		4	24VAC Input	24VAC	Blue
J2	To 24VAC Gas Valve	8076449	1	24VAC Out	24VAC	Orange
			2	Ground		
	From Ignition Module NC		3	Alarm In	24VAC	Yellow
	From Module / Gas Valve PV1		4	24VAC Input	24VAC	Orange
	To 24VAC Time Delay Relay Board /Ignition Module		5	24VAC Out	24VAC	Red
	From Ignition Module MV1		6	2VAC Input	24VAC	Orange
	Float Bypass Relay		21	12VDC	12VDC	Orange
	Coil Voltage		22	12VDC	12VDC	Orange
J3	ATO Probe	8263286	1	Ground		Yellow
			2	RTD		Red
			3			
J6	From Controller		1	C-BUS +	5VDC	
			2	C-BUS -	5VDC	
			3	5VDC	5VDC	
			4	RS485 -	5VDC	
			5	RS485 +	5VDC	
			6	Signal Ground		
			7	12VDC	12VDC	
			8	Signal Ground		
J7	C-Bus Harness	8076106 or 8075550 or (8075632 Resistor)	1	5VDC+	+5VDC	
			2	CAN High		
			3	CAN Low		
			4	Ground		
J8	C-Bus Harness or Network Resistor (pins 2 & 3)	8075549 or 8075550 or (8075632 Resistor)	1	5VDC+	+5VDC	
			2	CAN High		
			3	CAN Low		
			4	Ground		
J9	P-Bus Power Communication from SIB to VIB RJ11	8075555	1	Ground		
			2	P-BUS power	+5VDC	
			3	Modbus RS485 B		
			4	Modbus RS485 A		
			5	Signal ground		
			6	P-BUS power	+12VDC	
J10	P-Bus Power Communication		1	Ground		
			2	P-BUS power	+5VDC	
			3	Modbus RS485 B		
			4	Modbus RS485 A		
			5	Signal ground		
			6	P-BUS power	+12VDC	
J11	Cooking Probe	8263642	1	Ground		Yellow
			2	Probe		Red

### 1.11 Accessing Fryers for Servicing

Before performing any maintenance on your Frymaster fryer, shut off the gas supply to the unit and disconnect the fryer from the electrical power supply. Remove any attached restraining devices.



**DANGER**

**Moving a fryer filled with oil may cause spilling or splattering of the hot liquid. Follow the Drain to Pan instructions in Chapter 2 of the FQ4000-120 Controller Operation Manual before attempting to relocate a fryer for servicing.**

1. Shut off the gas supply to the unit. Unplug the power cords. Disconnect the unit from the gas supply.
2. Remove any attached restraining devices and relocate the fryer for service accessibility.
3. After servicing is complete, reconnect the unit to the gas supply and turn on gas supply, reattach restraining devices, and plug in the electrical cords.

### 1.12 Cleaning the Gas Valve Vent Tube

1. Set the fryer power switch and the gas valve to the OFF position.
2. Carefully unscrew the vent tube from the gas valve. **NOTE:** The vent tube may be straightened for ease of removal.
3. Pass a piece of ordinary binding wire (.052-inch diameter) through the tube to remove any obstruction.
4. Remove the wire and blow through the tube to ensure it is clear.
5. Reinstall the tube and bend it so that the opening is pointing downward.

### 1.13 Checking the Burner Manifold Gas Pressure

1. **On non-CE fryers only** ensure that the gas valve knob is in the OFF position (see Figure 1A).

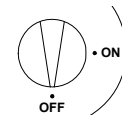

Figure 1A

2. Remove the pressure tap plug from the gas valve assembly (see Figure 1B).
3. Insert the fitting for a gas pressure-measuring device into the pressure tap hole.
4. **On non-CE fryers only**, place the gas valve in the ON position
5. Place the fryer power switch in the ON position. When the burner has lit and burned steadily for at least one minute, compare the gas pressure reading to the pressure for the corresponding gas in the appropriate table on the following page. The tables on the following page list the burner manifold gas pressures for each of the gas types that can be used with this equipment.
6. To adjust the burner gas pressure, remove the cap from the gas valve regulator and adjust to the correct pressure.

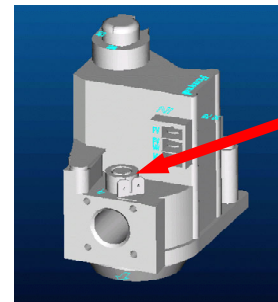

Figure 1B



GAS VALVE REGULATOR CAP

7. Place the fryer power switch (and the gas valve in non-CE fryers) in the OFF position. Remove the fitting from the pressure tap hole and reinstall the pressure tap plug.

Non- CE Standard for Incoming Gas Pressure						
Fryer Model	FQG80T		FQG100T		FQG120T	
Gas Type	Nat	LP	Nat	LP	Nat	LP
Incoming Min Pressure W.C/kpa/mbar	6/1.49/14.93	11/2.74/27.37	6/1.49/14.93	11/2.74/27.37	6/1.49/14.93	11/2.74/27.37
Incoming Max Pressure W.C/kpa/mbar	14.00/3.48/34.84	14.00/3.48/34.84	14.00/3.48/34.84	14.00/3.48/34.84	14.00/3.48/34.84	14.00/3.48/34.84

CE Standard for Incoming Gas Pressure												
Fryer Model	FQG80T				FQG100T				FQG120T			
Gas Type	G20	G25	G30	G31	G20	G25	G30	G31	G20	G25	G30	G31
Pressure (mbar) (1) mbar=10, 2mm H <sub>2</sub> O	20	20 or 25	28/30 or 50	37 or 50	20	20 or 25	28/30 or 50	37 or 50	20	20 or 25	28/30 or 50	37 or 50

UKCA Standard for Incoming Gas Pressure												
Fryer Model	FQG80T				FQG100T				FQG120T			
Gas Type	G20	G25	G30	G31	G20	G25	G30	G31	G20	G25	G30	G31
Pressure (mbar) (1) mbar=10, 2mm H <sub>2</sub> O	20	20 or 25	28/30 or 50	37 or 50	20	20 or 25	28/30 or 50	37 or 50	20	20 or 25	28/30 or 50	37 or 50

Australia Standard for Incoming Gas Pressure						
Fryer Model	FQG80T		FQG100T		FQG120T	
Gas Type	Nat	LP	Nat	LP	Nat	LP
Incoming Min Pressure W.C/kpa/mbar	TBD	TBD	TBD	TBD	4.54/1.13/11.30	11.05/2.75/27.50
Incoming Max Pressure W.C/kpa/mbar	TBD	TBD	TBD	TBD	14.00/3.48/34.84	14.00/3.48/34.84

Korea Standard for Incoming Gas Pressure						
Fryer Model	FQG80T		FQG100T		FQG120T	
Gas Type	Nat	LP	Nat	LP	LNG (Natural)	LPG (Propane)
Incoming Min Pressure W.C/kpa/mbar	TBD	TBD	TBD	TBD	4/1.00/10.00	9.2/2.30/23.00
Incoming Max Pressure W.C/kpa/mbar	TBD	TBD	TBD	TBD	10/2.50/25.00	13.2/3.30/33.00

 **DANGER**

**When pressure-testing incoming gas supply lines, disconnect the fryer from the gas line if the test pressure is ½" PSI [3.45 kPa (14 inches W.C.)] or greater to avoid damage to the fryer's gas piping and gas valve(s).**

**NOTE:** External gas regulators are not normally required on this fryer. A safety control valve protects the fryer against pressure fluctuations. If the incoming pressure is in excess of ½" PSI (3.45 kPa/35 mbar), a **step-down regulator** is required.

## 1.14 Adjusting the Pilot Flame

1. Remove the cap from the pilot adjustment screw hole on the gas valve.
2. Using a small, flat-tipped screwdriver, turn the pilot adjusting screw counterclockwise to increase length of flame or clockwise to decrease length of flame. Adjust to obtain a flame from 1 inch to 1½ inches long.
3. Reinstall the pilot adjustment screw cap.

## 1.15 Replacing Fryer Components

### 1.15.1 Replacing the Controller

1. **Disconnect the fryer from the electrical power supply. The fuse located at the bottom of the control box can be removed to remove power from individual control boxes.**
2. The controller is held in place by two screws in upper corners.
3. Remove the two screws from the upper corners of the controller.
4. Slide the controller up and it will swing open from the top.
5. Disconnect the RJ45 cable from the SIB board **FIRST** (see Figure 2).
6. Disconnect the other cables from the connectors on the back of the controller marking their position for reassembly.
7. Disconnect the lanyard tether.
8. Remove the controller.

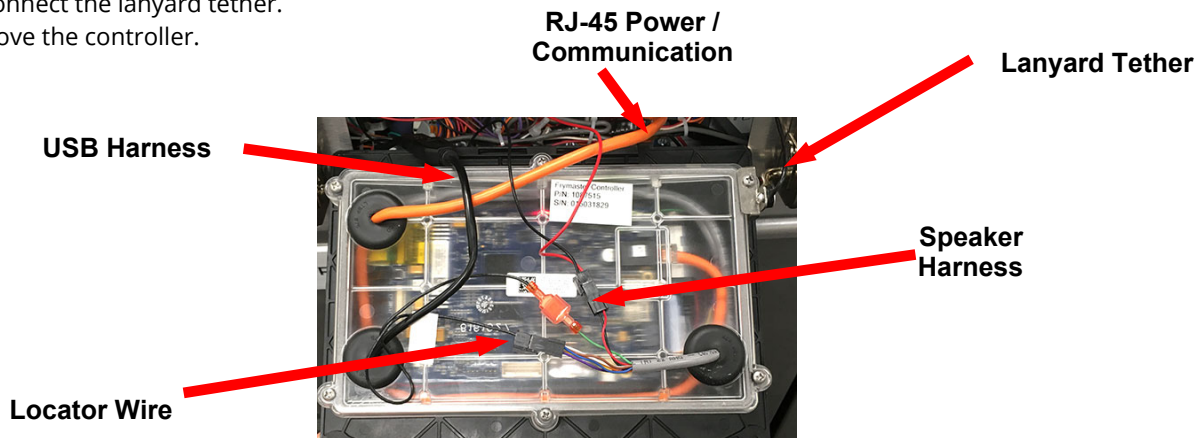

Figure 2

5. With the replacement controller face down resting in the control box, **reattach the lanyard tether FIRST**. Failure to reinstall lanyard could result in damage to the SIB board.
6. Reinstall the controller by reversing steps 1 thru 6. **NOTE: Common controllers won't require the locator wire. Tuck back into the control box. Common controllers vat ID is set up in Settings>Tech Service>Vat ID.**
7. Setup the controller following the instructions in section 1.7 of the FQ4000 Controller Operation Manual. If the controller being replaced is in the far-left position the current date and time will need to be setup following the instruction in section 1.8 of the FQ4000 Controller Operation Manual. Setup **MUST** be performed prior to reset.
8. Once setup is complete on all replaced controllers, CYCLE POWER TO ENTIRE FRYER SYSTEM. See section 1.20.2 to reset control power.
9. Check software version and if necessary, update the software. If a software update was necessary, follow the instructions to update the software in section 1.24.

### 1.15.2 Replacing Control Box Components

(Smart Interface Board (SIB), the Filtration Interface Board (FIB), Time Delay Relay Board, KCCM (SUI) communication board, or the Ignition Module) (NOTE: All components are not present in each component box.)

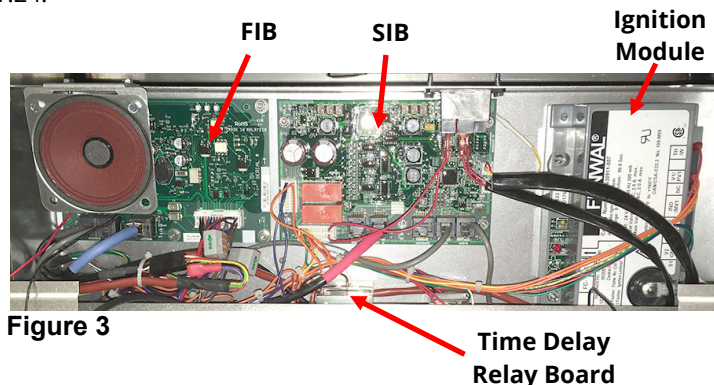

Figure 3

1. Perform steps 1 through 8 from section 1.15.1.
2. Remove the bezel by removing the two (2) screws on the bottom of the bezel.

3. Disconnect the cables attached to the component, marking or making a note of the connectors to facilitate reconnection.
4. Remove the hardware attaching the components.
5. Remove the component from the box. When removing the boards, be careful not to lose the spacers that fit over the studs behind the boards.
6. Reverse the procedure to install the component. Ensure the spacers behind the board are in place and the controller locator wire is attached to a stud.
7. Check software version and if necessary, update the software. If a software update was necessary, follow the instructions to update the software in section 1.24. **Press the information (?) button; press the down arrow; press the SW version button to verify software version of the FIB. If the FIB software version is not visible, the FIB may not be connected properly.**

### 1.15.3 Overview of Vat Components

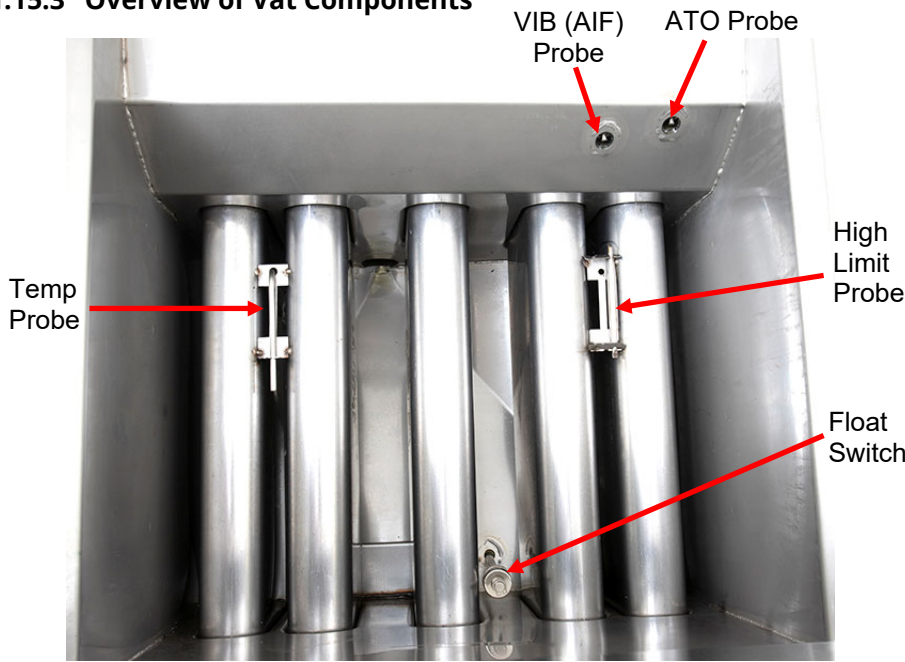

Figure 4



Figure 5

### 1.15.4 Replacing the Temperature Probe

1. Drain the cooking oil from the frypot. Allow the frypot to cool completely before proceeding.
2. Perform steps 1 through 8 from section 1.15.1.
3. Remove the bezel removing the two (2) screws on the bottom of the bezel (see Figure 5).
4. Disconnect the temperature probe (J11) from the SIB board (see Figure 6).
5. Locate the temperature probe to be replaced inside the frypot (see Figure 4).
6. Using pliers or a screwdriver, carefully bend the two tabs (one forward and toward the back) so the probe will clear the tabs (see Figure 7).
7. Removal of other components and/or repositioning the fryer may be necessary to gain access to the bottom of the probe. Remove the side access panel if applicable.
8. Carefully loosen the compression fitting around the temperature probe (see Figure 8).
9. Carefully remove the probe by pulling it through the bottom of the frypot. As the probe is removed, tilt the probe at an angle to facilitate removal. Retain the mounting hardware for reassembly.
10. Carefully pull the probe and insulation out of the control box, noting the path.

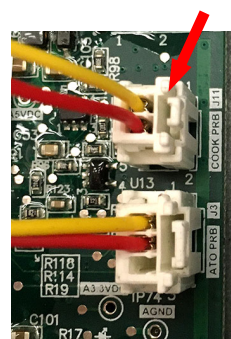

Figure 6



Figure 7



Figure 8  
Temperature Probe – Lower View



11. Remove the insulation from the old temperature probe wires to reuse on the new temperature probe.
12. Feed the new temperature probe from the top side of the frypot.
13. Apply Loctite™ PST 567 or equivalent sealant to the threads of the replacement and loosely attach the compression fittings.
14. Mount the temperature probe into the mounting bracket by carefully bending the two tabs back into alignment to retain the probe.
15. Using the hardware removed from step 9, securely tighten the compression fitting.
16. Using the wire insulation from step 11, slip the insulation over the new probe wires.
17. Route the wires to and through the control box.
18. Reverse steps 2-4.
19. Once the fryer is filled with oil check for leaks and proper operation.

### 1.15.5 Replacing the High Limit Probe

1. Drain the cooking oil from the frypot. Allow the frypot to cool completely before proceeding.
2. Perform steps 1 through 8 from section 1.15.1.
3. Remove the bezel removing the two (2) screws on the bottom of the bezel (see Figure 5 from section 1.15.4).
4. Locate the high-limit probe to be replaced inside the frypot (see Figure 4).
5. Using pliers, carefully bend the outer tab at the rear of the high limit until the high limit can slide back and out of the retaining bracket (see Figure 9).
6. Removal of other components and/or repositioning the fryer may be necessary to gain access to the bottom of the probe. Remove the side access panel if applicable.
7. Carefully loosen and completely unscrew the compression nut, then the pass-through nut on the frypot bottom (see Figure 10).
8. Carefully remove and pull the high-limit capillary tube and bulb through the bottom of the frypot (see Figure 11).
9. Remove two screws securing the high-limit mounting-bracket (see Figure 12).
10. Mark and disconnect the wires from the high limit in the control box (see Figure 13).



Figure 9

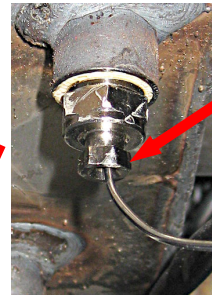

Figure 10  
Lower View

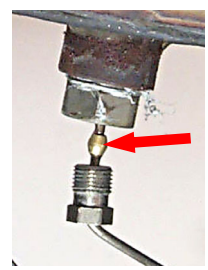

Figure 11

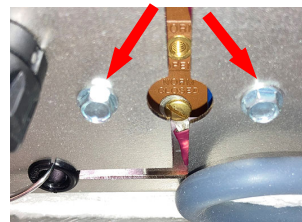

Figure 12

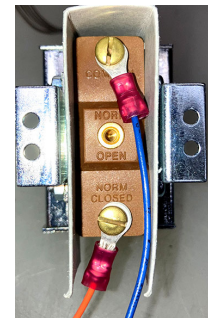

Figure 13

11. Remove the high limit from fryer by pulling the capillary tube and bulb through the control box opening.
12. Reverse the steps above for the high limit installation. Ensure that Loctite™ PST 567 or equivalent sealant is applied to the threads of the replacement and screw it securely into the frypot. **IMPORTANT: When installing new high limit, ensure the capillary tube and bulb are positioned properly with tab back in alignment prior to tightening the compression nut. Once tightened, the capillary tube cannot be repositioned.**
13. Once the fryer is filled with oil check for leaks and proper operation.

### 1.15.6 Replacing the Float Switch.

1. Drain the cooking oil from the frypot. Allow the frypot to cool completely before proceeding.
2. Disconnect the fryer from the electrical power supply.
3. Mark the position of the float switch in the frypot (see Figure 4 on the previous page). Ensure when removing the float switch that its position is clearly marked and replaced properly. Installing the float upside down will change the switch from N/O to N/C. This could allow the empty frypot to ignite.
4. Removal of other components and/or repositioning the fryer may be necessary to gain access to the bottom of the float

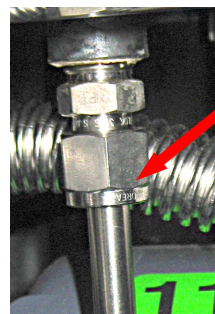

Figure 14

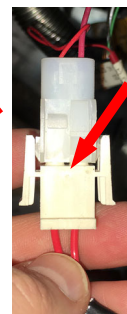

Figure 15



Figure 16

- switch (see Figure 14). Remove the side access panel if applicable.
5. Disconnect the two-pin connector from the float switch (see Figure 15).
6. Using a pin-pusher push the pins of the float switch out of the connector.
7. Remove the insulation from the old float switch wires and reuse on the new float switch.
8. Remove the retaining ring at the top of the float (see Figure 16).
9. Remove the float barrel from the shaft (see Figure 16).
10. Carefully loosen the compression fitting around the bottom of the float switch (see Figure 14).
11. Carefully remove the float switch shaft by pulling it through the bottom of the frypot. Retain the mounting hardware for reassembly.
12. Feed the new float switch wires from the top side of the frypot.
13. Apply Loctite™ PST 567 or equivalent sealant to the threads of the replacement and loosely attach the compression fittings.
14. Mount the float switch shaft to the proper height in the frypot.
15. Using the hardware removed from step 10, securely tighten the compression fitting.
16. Using the wire insulation from step 7, slip the insulation over the new probe wires.
17. Push pins into two-pin connector removed in step 6.
18. Reconnect two-pin connector disconnected in step 5.
19. Lower the float switch barrel over the float switch shaft.
20. Attach the retaining ring.
21. Reverse steps 1-4 to return the fryer to service.
22. Once the fryer is filled with oil check for leaks and proper operation.

### 1.15.7 Replacing the ATO Probe

1. Disconnect the fryer from the electrical supply or remove fuse on bottom of associated control box.
2. Drain cooking oil below the level of the ATO probe to be replaced (see Figure 17). The ATO probe is the uppermost probe in the wall of the frypot.
3. Perform steps 1 through 8 from section 1.15.1.
4. Remove the bezel removing the two (2) screws on the bottom of the bezel (see Figure 5 from section 1.15.4).
5. Remove the four (4) screws (two (2) on each side), attaching the control box to the fryer (see Figure 18).
6. Lower the control box by pushing gently down on the top, to gain access to the ATO probe (see Figure 19).
7. Disconnect the ATO probe (J3) from the SIB board (see Figure 20).
8. Gently fish the ATO probe harness back through the top of the control box.
9. Unscrew the probe from the frypot (see Figure 21).
10. Apply Loctite® PST56765 pipe thread sealant or equivalent to the replacement part threads and screw the replacement part into the frypot. **Ensure the probe is flush with the side of the vat** prior to tightening. Torque the probe to 180 inch-pounds.
11. Reverse steps 1 through 8 to return the fryer to service.
12. Once the fryer is filled with oil check for leaks and proper operation.



Figure 17



Figure 18



Figure 19

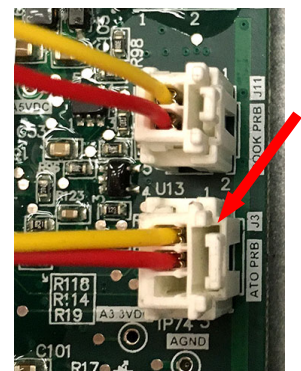

Figure 20

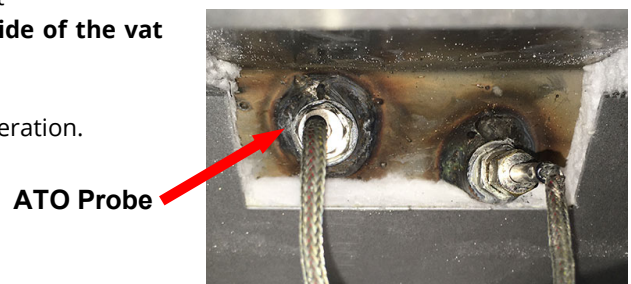

Figure 21



### 1.15.8 Replacing the VIB (AIF) Probe

1. Disconnect the fryer from the electrical supply or remove fuse on bottom of associated control box.
2. Drain cooking oil below the level of the VIB (AIF) probe to be replaced (see Figure 22). The VIB (AIF) probe is the lower probe in the wall of the frypot.
3. Perform steps 1 through 8 from section 1.15.1.
4. Remove the bezel removing the two (2) screws on the bottom of the bezel (see Figure 5 from section 1.15.4).
5. Remove the four (4) screws (two (2) on each side), attaching the control box to the fryer (see Figure 23).
6. Lower the control box by pushing gently down on the top, to gain access to the VIB (AIF) probe (see Figure 24).
7. Disconnect the J1 connector on the VIB board. (see Figure 25).
8. The VIB (AIF) probe is connected to pins 1 & 2 on the connector (see Figure 26). NOTE: Pin 1 is noted by an arrow in the bottom right corner.
9. The pins are held in with small tabs (see Figure 10).
10. Using a small object such as a small screwdriver or paperclip, lift the tab of pins 1 and 2 to release the pins, while gently pulling on the wires (see Figure 28).
11. Unscrew the VIB (AIF) probe from the frypot (see Figure 29).
12. Apply Loctite® PST56765 pipe thread sealant or equivalent to the replacement part threads and screw the replacement part into the frypot. **Ensure the probe is flush with the inside of the vat** prior to tightening. Torque the probe to 180 inch-pounds.
13. Reverse steps 1 through 8 to return the fryer to service.
14. Once the fryer is filled with oil check for leaks and proper operation.

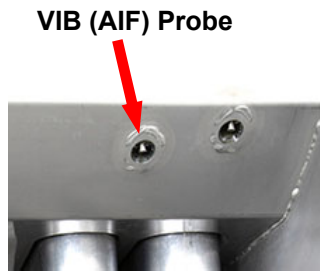

Figure 22

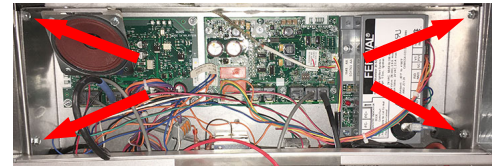

Figure 23



Figure 24

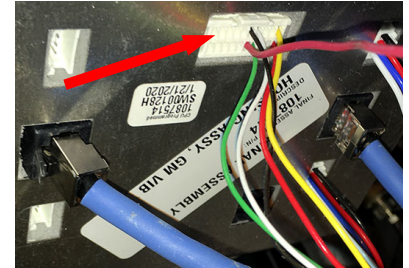

Figure 25

27).

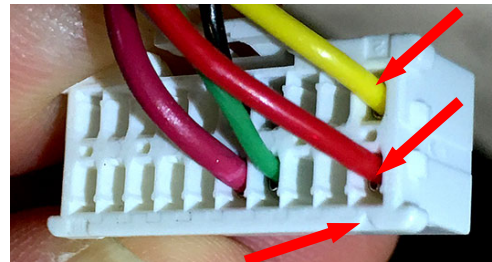

Figure 26

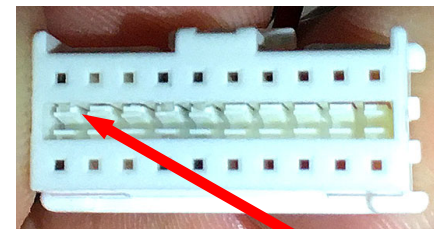

Figure 27

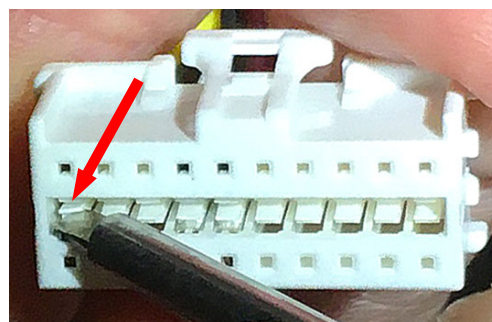

Figure 28

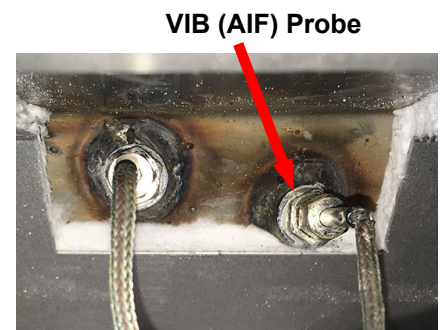

Figure 29

### 1.15.9 Replacing a Gas Valve

1. Disconnect fryer from electrical and gas supplies.
2. Disconnect the wires from the gas valve.
3. Disconnect any flexlines.
4. Remove the pilot gas line fitting from the gas valve.
5. Carefully unscrew the valve from the manifold. **NOTE:** Some models may have the valve attached to the manifold by means of a pipe union. In such cases, remove the valve by uncoupling the union. Some models may require removal of the manifold.



- Remove all fittings from the old gas valve and install them on the replacement valve, using Loctite® PST56765 or equivalent pipe thread sealant. Do not apply sealant to the first two pipe threads. Doing so will clog and damage the gas valve.
- Reverse steps 2-5 to install the replacement gas valve.
- Reconnect the fryer to the gas supply and open the cut off valve. Apply a thick soapy solution of soapy water around each connection to check for gas leaks and ensure there are no bubbles. Eliminate any that are found. There should be no smell of gas.
- Reconnect the fryer to the electrical power supply and check for proper operation.

#### 1.15.10 Replacing the Pilot Assembly or Trailing Pilot Assembly

- Remove the pilot tubing from the bottom of the pilot assembly.
- If the pilot is the ignition pilot, disconnect the ignition cable and the sense wire.
- Remove the pilot mounting screw(s) from the pilot mounting bracket and remove the pilot.
- Reverse the procedure to replace the pilot assembly. Disconnect fryer from electrical and

#### 1.15.11 Adjusting the Ignitor Assembly

- Disconnect the fryer from the electrical supply.
- Remove the outer cover plate by removing two screws as shown in Figure 30.
- Remove the air shutter plate if applicable by removing the four screws in the four corners as shown in Figure 31.
- Gently bend the ignitor spark probe until the gap distance is approximately  $\frac{1}{4}$ " inch between the two points as shown in Figure 32.
- Reverse the steps to reassemble.

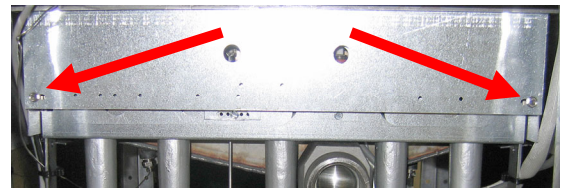

Figure 30

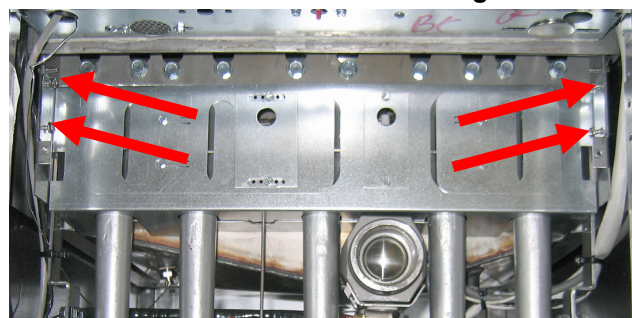

Figure 31



Figure 32

#### 1.15.12 Replacing the Filter Motor or Filter Pump

- Disconnect the unit from the electrical power supply.
- Remove the filter pan from the unit.
- Position a container beneath the oil return fitting at the front of the cabinet. Disconnect the flexible oil line from the fitting, allowing any residual oil to drain into the container.
- At the rear of the fryer, unplug the left connector (as viewed from the rear of the fryer) from the transformer box.
- Remove the four nuts and bolts attaching the motor mount to the rear motor mount support.
- At the front of the fryer, remove the cover plate from the front of the motor and disconnect the motor wires.
- Place a 1-foot (30.5-cm) length of wood (or similar support) beneath the motor mount near the front of the unit and remove the two remaining nuts and bolts attaching the motor mount to the front cabinet cross brace.
- Carefully remove the support and lower the motor mount to the floor, allowing the rear of the mount to slide forward and off the rear motor mount support.
- Disconnect the return flexline from the pump. The motor and pump assembly can now be pulled from beneath the fryer and the failed component can be removed and replaced.
- Position the replacement motor and pump assembly beneath the fryer and reconnect the oil return flexline to the pump. Lift the rear of the motor mount up and onto the rear motor mount support.
- Lift the front of the motor mount up and support it with a 1-foot (30.5-cm) piece of wood or a similar support. Install but do not tighten the two nuts and bolts that attach the motor mount to the front cabinet cross-brace.
- Install and tighten the four nuts and bolts that secure the motor mount to the rear motor mount support.

13. At the front of the fryer, tighten the two nuts and bolts at the front of the motor mount. Reconnect the motor power wires and reinstall the wiring cover plate.
14. Reconnect the oil return flexline and reinstall the filter pan.
15. Reconnect the unit to the electrical power supply, fill the frypots with oil and check for proper operation.

### 1.15.13 Replacing the Frypot

1. If restraints are installed on the fryer, disconnect restraints prior to disconnecting the gas supply line.
2. Disconnect the fryer from the electrical and gas supplies.
3. Reposition the fryer to gain access to both the front and rear of the fryer.
4. Remove fryer door associated with the frypot replacement to simplify removal.
5. Remove the basket hanger. Units with basket lifts will require removal of the lift arms prior to removing the basket hanger.
6. Remove the filter pan from the unit and drain the frypot being replaced into a Shortening Disposal Unit (SDU) or other appropriate metal container using the drain to pan function following the instructions in section 2.1.10 of the FQ4000 Controller Operation Manual.



**DANGER**

**DO NOT attempt to drain more than one full frypot or two split frypots into the SDU at one time.**

7. Remove the top screws in the upper corners of the controller.
8. Grasp the upper edge of each controller and swing the controller downward. Unplug the controller wiring harnesses and grounding wire.
9. Remove the controller by disconnecting the tether and lifting it out of the control box.
10. Remove the top cap by removing the nuts attached to the underside on each end and lifting the top cap straight up.
11. Remove any joiner strips from the center of frypots on two battery or larger units. Be careful not to bend the joiner strip during removal.
12. Disconnect the ATO and Temperature probe sensor from the SIB boards marking each wire to facilitate re-assembly.
13. Cut any ties that prevent the box from being lowered below or pulled out of the control panel frame.
14. Remove the two mounting screws on each side of the component box.
15. Carefully disconnect any wires that keep it in place and gently move out of the way.
16. Remove the section(s) of drain from the drain valve(s) of the frypot to be removed.
  - Remove the nuts holding the drain valve strap onto the drain tube stud.
  - Disconnect the Teflon tube at the back of the center dump tube piece and any other components attached to the tubes, including drain flush flexlines.
  - Loosen the nut on each clamp holding the rubber boots and drain sections together.
  - Carefully remove the tubes by pulling down at an angle, straight out of the drain valves, and working them gently out of the rubber boots. Set aside for reassembly.
17. Remove the burner retaining shields and plates by loosening the screw on each end.
18. Remove the burners to gain access to the temperature probe and to ease removal. Remove one burner at a time. Loosen the two screws attaching the burner to the burner rail. Slide the burner up until the heads of the two screws reach the round key holes and lean it slightly toward from the frypot to clear the burner rail and seal (metal box attached to frypot). Then, pull the burner up and off the orifice. The burners should be easy to remove and do not require force.
19. Remove the burner rail when all burners have been uninstalled. Loosen the screws on each end of the rail and set it aside.
20. Disconnect the ignition cable from the ignitor.
21. Disconnect the flame sensor wires.
22. Disconnect the pilot and trailing pilot tubes.
23. Disconnect the pilot and trailing pilot.
24. Remove back panels of the fryer. There may be both upper and lower panels and several screws secure them. Screw location and orientation will vary according to fryer model.
25. Remove screw securing brace (and back panel) to the flue cap. Support the brace with hand while removing screw to prevent brace from falling away. Remove brace and set aside for reassembly.

26. Remove screws securing flue cap to frypot (access from above; a nut-driver with an extension or long screwdriver is required). Use care not to drop the screws into the flues. If this happens, the screws can be retrieved when the flue is removed. Use a screwdriver or similar tool to free flue cap from frypots. Remove flue cap by lifting up and off of fryer.
27. Remove gas manifold pipe for access to gas manifold shield by disconnecting at the unions. Ensure gas supply is shut off and supply line is disconnected prior to removing. Set gas manifold aside. Remove screws securing gas manifold shield. Remove shield to access oil-return plumbing components connected to the frypots.
28. Remove screws securing flue to frypot (access from above; a nut-driver with an extension or long screwdriver is required). Retrieve any screws dropped into the flue during removal of the flue cap and frypot bracket.
29. Disconnect the oil return line(s) from the frypot to be removed.
30. Remove the VIB (AIF) probe from the frypot.
31. Disconnect all wiring from the VIB (valve interface board).
32. Disconnect the actuators from the return and drain valves.
33. Remove bolts from brackets securing burner manifold to frypot. Leave the manifold in place.
34. Ensure wires and tubes will not be caught on the frypot when it is removed
35. Remove frypot from fryer by lifting up and out of the cabinet.
36. Position the frypot upside down on a suitable work surface
37. Record position of the valve stem in relation to the frypot prior to removing the drain valve. Using a suitable wrench, remove the drain valve from the frypot. Use Loctite PST567 sealant when installing drain valve on replacement frypot.
38. Remove all other hardware and accessories from the frypot.
39. Reverse the above steps to install the replacement frypot.



#### **CAUTION**

**Before installing temperature probes, high-limit thermostats, float switches, VIB (AIF) and ATO probes, return valves and drain valves on replacement frypot, clean the threads and apply Loctite® PST56765 thread sealant or equivalent.**

### **1.15.14 Replacing Transformer Box Components (Transformers, Pump Motor Relay, Reset Switch Relay and Power Supply)**

1. Disconnect the fryer from the electrical supply.
2. Relocate the fryer to gain access to the transformer box.
3. Disconnect wire harnesses and remove the transformer box by removing the nuts that secure the transformer box to the fryer.
4. Remove the transformer cover.
5. Mark wires to ease reassembly.
6. Remove and replace the failed component.
7. Reverse the steps to reassemble.

### **1.16 Troubleshooting and Problem Isolation**

Because it is not feasible to attempt to include in this manual every conceivable problem or trouble condition that might be encountered, this section is intended to provide technicians with a general knowledge of the broad problem categories associated with this equipment, and the probable causes of each. With this knowledge, the technician should be able to isolate and correct any problem encountered.

Problems you are likely to encounter can be grouped into six categories:

1. Ignition or Heating failure
2. Improper burner function
3. Improper temperature control
4. Controller or board malfunctions
5. Filtration malfunctions
6. Leakage
7. Basket lift malfunction.

The probable causes of each category are discussed in the following sections. A series of troubleshooting steps assist in solving some of the more common problems.

### 1.16.1 Heating (Ignition) Failure

Heating (ignition) failure occurs when the ignition module fails to sense a pilot flame within the 90-second time delay period and locks out. When this happens, the module sends 24 VAC through the SIB (smart interface board) alarm circuit to the controller.

FQ4000 controllers display **"HEATING FAILURE"**.

The three primary reasons for heating failure, listed in order of probability, are problems related to:

1. Float switch malfunction
2. Gas and/or electrical power supplies
3. Electronic circuits
4. Gas valve

#### PROBLEMS RELATED TO THE FLOAT SWITCH

The main indicators of this are that the fryer may light intermittently, fail to light or light with low oil levels. A visual clue is the float switch (see Figure 33) is stuck in the down position with oil over it or stuck in the up position with the oil level below it. Regular cleaning of the float switch prevents this issue. Ensure when removing the float switch that its position is clearly marked and replaced properly. Installing the float upside down will change the switch from N/O to N/C. This could allow the empty frypot to ignite. See float switch troubleshooting in Section 1.22.5.1.



Figure 33

#### PROBLEMS RELATED TO THE GAS AND/OR ELECTRICAL POWER SUPPLIES

The main indicators of this are that an entire battery of fryers fails to light and/or there are no indicator lights illuminated on the fryer experiencing heating failure. Verify that the quick disconnect fitting is properly connected, the fryer is plugged in with connector twisted and locked, the main gas supply valve is open, and the circuit breaker for the fryer electrical supply is not tripped.

#### PROBLEMS RELATED TO THE ELECTRONIC CIRCUITS

If gas and electrical power are being supplied to the fryer, the next most likely cause of heating failure is a problem in the 24 VAC circuit. Verify that the float switch is working properly. Installing it upside down will change the switch from N/O to N/C. This could allow the empty frypot to ignite.

#### TROUBLESHOOTING THE 24 VAC CIRCUIT.

Some typical causes of heating failure in this category include a defective sensing wire in the ignitor assembly, a defective module, a defective ignition wire, and a defective ignitor.

Occasionally, a heating failure situation occurs in which all components appear to be serviceable, but the unit nevertheless goes into heating failure during operation. The probable cause in this case is an intermittent failure of an ignition module. When the unit is opened up for troubleshooting, the module cools down enough to operate correctly; however, when the unit is again closed up and placed back into service the module heats up and fails.

#### PROBLEMS RELATED TO THE GAS VALVE

If the problem is not in the 24 VAC circuit or pilot system, it is most likely in the gas valve, itself. Before replacing the gas valve, refer to Section 1.17.2 **TROUBLESHOOTING THE GAS VALVE.**

## 1.16.2 Improper Burner Function

With problems in this category, the burner ignites but exhibits abnormal characteristics such as “popping,” fluctuating flame intensity, and flames shooting out of the flue.

“**Popping**” indicates delayed ignition. In this condition, the main gas valve is opening but the burner is not immediately lighting. When ignition does take place, the excess gas “explodes” into flame, rather than smoothly igniting.

The primary causes of popping are:

- Low or fluctuating gas pressure
- Misdirected or weak pilot flame
- Clogged burner orifices
- Clogged burners
- Inadequate make-up air
- Heat-damaged controller or ignition module
- Out of adjustment ignitor
- Cracked ignitor or broken ignition wire
- Defective ignition module
- Missing or misaligned burners
- Clogged vent tube (causing incorrect gas pressure)
- Make up air blowing down the flue

If popping occurs only during peak operating hours, the problem may be incorrect or fluctuating gas pressure. Verify that the incoming gas pressure (pressure to the gas valve) is in accordance with the appropriate requirements listed in the Installation and Operation manual that came with the fryer, and that the pressure remains constant throughout all hours of usage. Refer to Section 1.13, **Checking the Burner Manifold Gas Pressure** in this manual for the procedure for checking the pressure of gas supplied to the burner and the recommended pressures, if burner manifold pressure is suspected of being incorrect.

If popping is consistent during all hours of operation, verify that the pilot is properly positioned above the burner orifice and that the pilot pressure is correct. Correct pilot pressure is indicated by a flame 1 to 1½" long. Also verify that igniter is properly adjusted (electrode tip 1/8" from pilot hood corner). Refer to Section 1.5 for pilot adjustment procedure.

Clogged burners or burner orifices are also likely causes of delayed ignition. Clogged burners are indicated by uneven flame or partial flame on the burner face. Clogged orifices are indicated by no flame.

Another cause of popping is an insufficient air supply or drafts that are blowing the pilot flame away from the burner. Check for "negative pressure" conditions in the kitchen area. If air is flowing into the kitchen area, this indicates that more air is being exhausted than is being replenished and the burners may be starved for air.

If the fryer’s gas and air supplies are okay, the problem most likely is with one of the electrical components. Examine the ignition module for signs of melting, distortion, or discoloration due to excessive heat build-up in the fryer. Also, examine the controller for the same conditions. This condition usually indicates improper flue performance. A melted or distorted ignition module is automatically suspect and should be replaced, but unless the condition causing excessive heat in the fryer is corrected, the problem is likely to recur.

Next, ensure the ignition wire is tightly connected at both ends and examine it for obvious signs of damage. Again, if damage is due to excessive heat in the fryer, that problem must also be corrected.

Check for proper operation by disconnecting the wire from the ignitor (spark plug), inserting the tip of a screwdriver into the terminal. With the **insulated handle** of the screwdriver, hold the shaft near the frame of the fryer as the power switch is placed in the “ON” position. A strong, blue spark should be generated for at least 60 seconds.



**Make sure you are holding the insulated handle of the screwdriver and not the blade. The sparking charge is approximately 25,000 volts.**

Examine the ignitor (spark plug) for any signs of cracking. A cracked ignitor must be replaced.

Ensure the gap setting of the igniter is correct (electrode tip 1/8" from pilot hood center and under the overhang).



**Burners lighting on the left side only** may be caused by a trailing pilot problem (four- and five-tube frypots) or improper burner manifold pressure.

**Fluctuating flame intensity** is normally caused by either improper or fluctuating incoming gas pressure but may also be the result of variations in the kitchen atmosphere. Verify incoming gas pressure in the same way as for "popping," discussed in the preceding paragraphs. Variations in the kitchen atmosphere are usually caused by air conditioning and/or ventilation systems starting and stopping during the day. As air conditioning/ventilation systems start and stop, the pressure in the kitchen may change from positive or neutral to negative, or vice versa. Changes in airflow patterns may affect flame intensity.

**Flames "rolling" out of the fryer** are usually an indication of negative pressure in the kitchen and make up air blowing down the flue. Air is being sucked out of the fryer enclosure and the flames are literally following the air. If negative pressure is not the cause, check for high burner-manifold gas pressure in accordance with the procedures in Section 1.13. An obstructed flue, which prevents the fryer from properly exhausting, may also be the cause.

**Excessively noisy burners** may indicate that the burner gas pressure is too low, the tube diffusers are defective or burned out, or it may simply be that the gas valve vent-tube is blocked (if applicable). If the gas pressure is correct, the tube diffusers are intact and in good condition, and the vent-tube is unobstructed (if applicable), the gas valve regulator is probably defective.

### 1.16.3 Improper Temperature Control

Temperature control, including the melt cycle, is a function of several interrelated components, each of which must operate correctly. The principal component is the temperature probe. **Ensure the temperature probe is parallel to the tube and not touching the tube.** Depending upon the specific configuration of the fryer, other components may include the smart interface board, the controller itself, and the ignition module.

Improper temperature control problems can be categorized into melt cycle and failure to control at setpoint problems.

#### MELT CYCLE PROBLEMS

Initiation of the melt cycle with FQ4000 controllers is automatic. Problems may originate from the controller itself, the temperature probe, float switch, or a malfunctioning heat relay on the SIB (Smart Interface Board) or the SIB (Smart Interface Board).

#### FAILURE TO CONTROL AT SETPOINT

Problems in this category may be caused by the temperature probe, the SIB (Smart Interface Board), or the controller.

### 1.16.4 Controller Malfunctions

#### RECOVERY TIME

*Recovery time* – is a method of measuring a fryer's performance. Put simply, it is the time required for the fryer to increase the oil temperature from 250°F to 300°F (121°C to 149°C). This range is used as a standard since ambient kitchen temperatures can affect the test if lower ranges are used.

The FQ4000 controller performs the recovery test each time the fryer warms up. An operator can view the results of the test any time the fryer is above the 300°F (149°C) point by pressing the ? button and then pressing the recovery button when the fryer is on. The test results will be displayed in minutes and seconds. The maximum acceptable recovery time for FQG80T/100T/120T Series gas fryers is four minutes (4:00).

### 1.16.5 Filtration Malfunctions

Most filtration problems arise from operator error. One of the most common errors is placing the filter envelope on the bottom of the filter pan rather than over the filter screen.

Whenever the complaint is "the pump is running, but no oil is being filtered," check the installation of the filter envelope, including that the correct size is being used. While you are checking the filter envelope, verify that the O-rings on the filter pan suction tube and pre-filter are present and in good condition. Missing or worn O-rings will allow the pump to suck



Figure 34

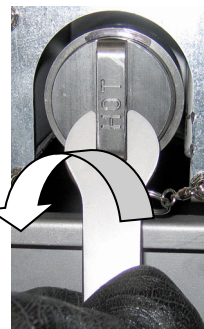

Figure 35

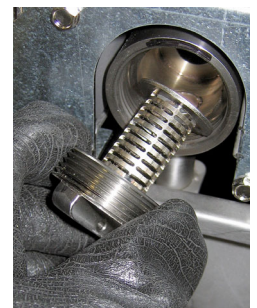

Figure 36

air and decrease its efficiency. Also check the pre-filter. A plugged pre-filter (see Figure 34) can slow the flow of oil. Use the attached wrench to open (see Figure 35) and clean the pre-filter (see Figure 36). Ensure the pre-filter is tight and the O-ring is present to prevent air from entering the line and causing slow oil return.

If the pump motor overheats, its thermal overload will trip, and the motor will not start until it is reset. If the pump motor does not start, press the reset switch located on the front of the motor. If the pump starts, something caused the motor to overheat. It may be attributed to several frypots in a large battery of fryers being filtered one after the other and the pump overheated. Letting the pump cool down for at least a half-hour is all that is required in this case. More often, the pump overheated for one of the following reasons:

- Shortening that remained in the pan after previous filtering solidified in the suction tube recess in the bottom of the pan or the suction tube, itself. Adding hot oil to the pan and waiting a few minutes will usually correct this problem. A flexible wire can be used to clean out the suction tube and the recess in the bottom of the pan. **NEVER** use compressed air to blow solidified shortening out of the suction tube.
- The operator attempted to filter oil that was not heated. Cold oil is thicker and causes the pump motor to work harder and overheat.

If the motor hums but the pump does not rotate, there is a blockage in the pump. Incorrectly sized or installed envelope will allow food particles and sediment to pass through the filter pan and into the pump. When sediment enters the pump, the gears can bind up and cause the motor to overload, tripping the thermal overload. Solidified shortening in the pump will also cause it to seize, with similar results.

A pump seized by debris or hard shortening can usually be freed by manually moving the gears with a screwdriver or other instrument as illustrated on the following page. **Ensure power to the pump motor is off before trying this.**

1. Disconnect power to the filter system.
  2. Remove the input plumbing from the pump.
  3. Use a screwdriver to manually turn the gears (see Figure 37).
- Turning the pump gears backwards will release a hard particle and allow its removal.
  - Turning the pump gears forward will push softer objects and solid shortening through the pump and allow free movement of the gears.
4. Prior to reassembly, the inside housing must be clean and free of any sediment or debris. If not, the gears will bind again after reassembly.

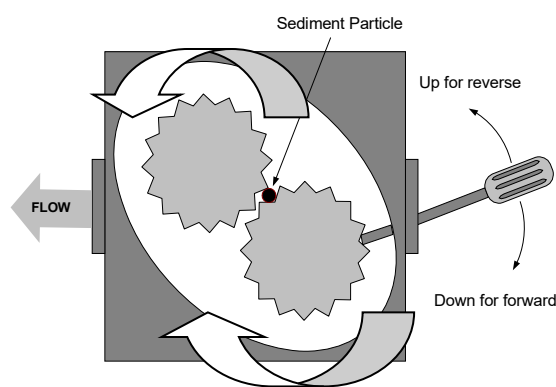

**Figure 37**  
Internal Oil Flow is illustrated by large arrows.

Incorrectly sized or incorrectly installed filter leaf envelope will allow food particles and sediment to pass through and clog the suction tube recess on the bottom of the filter pan or the suction tube, itself. Particles large enough to block the suction tube recess or the suction tube may indicate that the crumb tray is not being used.

Heater strips (if equipped) on the oil return plumbing are designed to prevent solidification of shortening left in the plumbing. Heater strips will not melt or prevent solidification of shortening in the filter pan.

Filter systems equipped with oil-return heater tape are wired into the 120 VAC source and remain energized as long as the unit is plugged in and power remains constant. Heater tape should receive constant power all day and all night; it should not be connected to a power supply that is turned off at night.

### 1.16.6 Leakage

Leakage of the frypot will usually be due to improperly sealed high-limit thermostats, RTD's, temperature probes, other sensors and drain fittings. When installed or replaced, each of these components must be sealed with Loctite® PST56765 sealant or equivalent to prevent leakage. In very rare cases, a leak may develop along one of the welded edges of the frypot. When this occurs, the frypot must be replaced.

If the sides or ends of the frypot are coated with oil, the most likely cause is spillage over the top of the frypot rather than leakage.

The clamps on the rubber boots that hold the drain tube sections together may loosen over time as the tubes expand and contract with heating and cooling during use. Also, the boot itself may be damaged. If the section of drain tube connected to the drain valve is removed for any reason, ensure that its rubber and clamps are in good condition and properly fitted around the drain tube when it is reinstalled. Also, check to ensure that the drain tube runs downward from the drain along its whole length and has no low points where oil may accumulate.

## 1.17 Troubleshooting Guides

The troubleshooting guides on the following pages are intended to assist service technicians in quickly isolating the probable causes of equipment malfunctions by following a logical, systematic process. An additional set of operators troubleshooting guides are contained in Chapter 5 of the FQG80T/100T/120T Series Installation and Operation Manual. It is suggested that service technicians thoroughly familiarize themselves with both sets.

### 1.17.1 Troubleshooting the 24 VAC Circuit

Prior to checking for problems associated with the 24 VAC circuit, ensure that the unit is connected to a power supply, and the controller is on and is calling for heat (heat indicator appears and displays PRE-HEAT).

**NOTE:** All voltage measurements must be made within **4 seconds** of the unit calling for heat. If unit does not fire within **4 seconds**, ignition modules will lock out and controller must be turned off, then on to reset.

**DO NOT CHECK WITH HARNESES UNPLUGGED AS SHORTING THE PINS MAY OCCUR WHICH WILL DAMAGE THE BOARD.**

The following processes will assist you in troubleshooting the 24 VAC circuit and ruling it out as a probable cause:

- **24 VAC is not present on the interface board J1 pin 1.**
  1. If LED's 2, 4 and 6 *are not* continually lit, the probable causes are a loose or blown fuse, failed 24 VAC transformer, or failed wiring between the transformer and interface board.
- **24 VAC is present on interface board J1 pin 1.**
  1. If 24 VAC *is not* present across the gas valve main coil (MV terminals), probable causes are an open high-limit thermostat or a failed wire between the interface board and gas valve.
    - a. Check continuity of high-limit thermostat. If it is zero, problem is in wiring.
  2. If 24 VAC *is* present on J2 pin 1, the probable causes are failed ignition module(s) or a failed interface board. Replace the questionable ignition module with one known to be good to isolate the cause.
  3. If 24 VAC *is* present across the gas valve main coil (MV terminals), the 24 VAC circuit is working, and the problem may be with the gas valve.
  4. If LED 3 *is not* continually lit with the controller in the ON position, the probable cause is a defective latch relay.
  5. If LED 1 *is not* continually lit with the controller in the ON position and calling for heat, the probable cause is a defective heat relay.

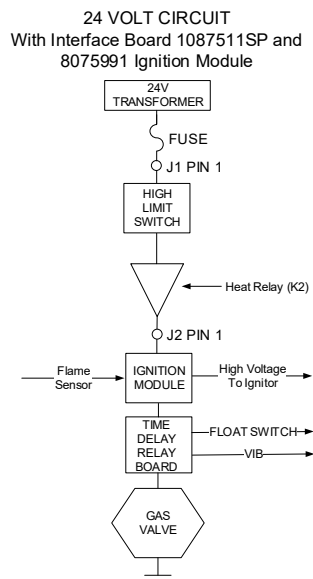

**Figure 38**



### 1.17.2 Troubleshooting the Gas Valve

Prior to checking for problems associated with the gas valve, ensure that the unit is calling for heat. Also, for non-CE units, verify that the gas valve is in the ON position.

The following processes will assist you in troubleshooting the gas valve and ruling it out as a probable cause:

- If 24 VAC is not present across gas valve main coil, the probable cause is the 24 VAC circuit. Refer to the 24 VAC circuit troubleshooting guide in section 1.17.1.
- If 24 VAC is present across gas valve main coil, check the incoming gas pressure and compare to the tables in section 1.13.
  1. If incoming gas pressure *is not* correct, the probable cause is a problem with the gas supply to fryer.
  2. If incoming gas pressure *is* correct, check the burner manifold gas pressure and compare it to the tables in section 1.13.
    - a. If burner manifold gas pressure *is not* correct, the probable cause is an improperly adjusted or failed gas valve. Adjust the valve by following the procedure “Check Burner Manifold Pressure” in Section 1.13 of this manual. If the valve cannot be adjusted, replace it.
    - b. If outgoing gas pressure *is* correct, the gas valve is okay.

### 1.17.3 Troubleshooting the Temperature Probe



**Disconnect the temperature probe from the SIB board before testing temperature probe resistances to avoid invalid readings**

Prior to checking for problems associated with the temperature probe, inspect the probe body for damage while it is still in the frypot. Remove and replace the probe if it is bent, dented, or cracked. Also, inspect leads for fraying, burning, breaks, and/or kinks. If found, replace the probe.

The following processes will assist you in troubleshooting the gas valve and ruling it out as a probable cause:

*Before testing the probe, determine the temperature of the cooking oil using a thermometer or pyrometer placed at the tip of the questionable probe.*

Unplug the temperature probe from the SIB board to test the resistance of the probe.

- **If resistance through the temperature probe is not approximately equal to that given in the Probe Resistance Chart in section 1.18 for the corresponding temperature, the probe has failed and must be replaced.**
- **If resistance through temperature probe is approximately equal to that given in the Probe Resistance Chart for the corresponding temperature, measure the resistance through each of the previously tested pins to ground.**
  1. If resistance *is not* 5 mega-Ohms or greater in each pin, the probe has failed and must be replaced.
  2. If resistance *is* 5 mega-Ohms or greater in each pin, the probe is okay.

### 1.17.4 Replacing the Reset Switch Relay

Disconnect the fryer from the electrical power supply. Relocate the fryer and remove the transformer box in the rear of the fryer. Replace the relay marking the wires to ease reassembly. Once replaced, reconnect the power.

## 1.18 Probe Resistance Chart

Probe Resistance Chart																	
<i>For use with FQG80T/100T/120T fryers manufactured with Minco RTD probes only.</i>																	
F	OHMS	C	F	OHMS	C	F	OHMS	C	F	OHMS	C	F	OHMS	C	F	OHMS	C
60	1059	16	130	1204	54	200	1350	93	270	1493	132	340	1634	171			
65	1070	18	135	1216	57	205	1361	96	275	1503	135	345	1644	174			
70	1080	21	140	1226	60	210	1371	99	280	1514	138	350	1654	177			
75	1091	24	145	1237	63	215	1381	102	285	1524	141	355	1664	179			
80	1101	27	150	1247	66	220	1391	104	290	1534	143	360	1674	182			
85	1112	29	155	1258	68	225	1402	107	295	1544	146	365	1684	185			
90	1122	32	160	1268	71	230	1412	110	300	1554	149	370	1694	188			
95	1133	35	165	1278	74	235	1422	113	305	1564	152	375	1704	191			
100	1143	38	170	1289	77	240	1432	116	310	1574	154	380	1714	193			
105	1154	41	175	1299	79	245	1442	118	315	1584	157	385	1724	196			
110	1164	43	180	1309	82	250	1453	121	320	1594	160	390	1734	199			
115	1174	46	185	1320	85	255	1463	124	325	1604	163	395	1744	202			
120	1185	49	190	1330	88	260	1473	127	330	1614	166	400	1754	204			
125	1195	52	195	1340	91	265	1483	129	335	1624	168	405	1764	207			

## 1.19 Manual Top-Off and Filtration Service Procedures

The fryer uses an ATO probe to detect low shortening level. When the shortening falls below the probe, the controller displays LOW OIL DETECTED, ADD OIL FROM THE NEXT FRYPOT or ADD FRESH SHORTENING. Once the shortening is manually added, press the check mark.

The FIB (Filter Interface Board) also oversees and controls filtration. It receives and sends data over the CAN (Controller Area Network) to and from various sensors, boards and controllers. It activates the filtration cycle sending information to the VIB (Valve Interface Board) boards controlling when actuators should open and close.

The FIB board is located inside the control box. The power for the FIB board and the filter pump relay is supplied from the 24VDC power supply from the transformer box. The 24VDC power supply also provides power, which passes through the FIB board to the VIB board, to the rotary actuators. The power for the VIB board microprocessor is supplied from the SIB.

### 1.19.1 FIB Troubleshooting

Problem	Probable Causes	Corrective Action
<b>No power to FIB board</b>	A. J1 connection unplugged. B. Power supply malfunction.	A. Check to ensure J1 on front of FIB board is fully locked into connector. B. Check that proper voltage is present at the power supply. See table in section 1.19.4.
<b>FQ4000 displays E29 TOP OFF PROBE FAILURE - CALL SERVICE</b>	A. Shorted or Open ATO RTD probe B. Bad Connection	A. With ATO probe covered in oil, press the "?" button. Press the down arrow. Press Software Version. Press the down arrow and ensure actual vat temperature and ATO RTD temperature are relatively close. If temperature reading is missing, unplug the ATO probe from the SIB board and check ATO probe resistance. If probe is bad, replace the probe. B. Ensure ATO probe is connected properly to SIB board. Ensure that the connector is terminated properly.

Problem	Probable Causes	Corrective Action
<p><b>FQ4000 displays E64 - FILTRATION INTERFACE BOARD FAILURE - FILTRATION DISABLED - CALL SERVICE</b></p>	<p>A. Bad Connection. B. FIB Board power loss. C. FIB board failure.</p>	<p>A. Enter the INFO mode, and select SOFTWARE, review the FIB software status. If FIB: 00.00.000 is shown, the communication is lost to the FIB.</p> <p>B. Cycle power off for 60 seconds or longer using the master power reset switch.</p> <p>C. Wait 5 minutes and repeat step A to check if a software version is shown other than zeros. If zeros are still present, skip to step D.</p> <p>D. Perform a FIB 2 RESET from the SERVICE&gt;SERVICE menu.</p> <p>E. Wait 5 minutes and repeat step A to check if a software version is shown other than zeros. If zeros are still present, go to step F.</p> <p>F. Ensure CAN connections between the SIB board and FIB board are secure. (Pressing the ? button shall display the FIB software version. If a software version of V00.00.000 is displayed and the FIB has power, a communication issue may be the cause).</p> <p>G. Repeat step A to check if a software version is shown other than zeros. If zeros are still present, go to step H.</p> <p>H. Ensure CAN connections between the SIB board vat 1 to SIB board vat 2 to SIB board vat 3 are all secure. Note: If the error is only showing on vat 1 there is a communication break between vat 1 &amp; 2. If the error is showing up on vat 1 and 2 then the error is in between vat 2 &amp; 3. If the error is showing on all pots, there is connection issue from vat 3 or higher to the FIB board; or the board is not getting power; or the board is not operational any longer and needs to be replaced.</p> <p>I. Repeat step A to check if a software version is shown other than zeros. If zeros are still present, go to step J.</p> <p>J. Ensure the cabling to the KCCM (SUI) board is properly connected and has not been damaged. If damaged, remove the cable and install a terminator into the FIB board.</p> <p>K. If the terminator was installed in the last step, repeat steps A thru E to see if communication is reestablished. If zeros are still present in INFO - SOFTWARE-FIB, move to step L.</p> <p>L. Power to the FIB board has been lost. Ensure there is correct voltage to the FIB power supply and from the FIB power supply. Restore power to the board and clear any service required errors. Replace FIB power supply. If the FIB board has a red led illuminated, power is present at the FIB board.</p> <p>M. If power is supplied at the FIB board in step L and all of the other steps above still reflect the E64, then replace FIB board. After replacing the FIB board, reset the system by powering the entire battery down for 60 seconds.</p>

## 1.19.2 Filtration Troubleshooting

Problem	Probable Causes	Corrective Action
<b>Quick Filter or Clean and Filter won't start.</b>	<ul style="list-style-type: none"> <li>A. Filter pan out of position.</li> <li>B. Oil level too low.</li> <li>C. Oil temperature is too low (OIL TOO COLD display).</li> <li>D. Filter relay has failed.</li> <li>E. Filter motor thermal switch is tripped.</li> <li>F. Filter in recipe setup is set to OFF (Auto only).</li> <li>G. Filter After set to "0".</li> <li>H. Filtration Lockout set for ENABLED.</li> <li>I. Error in system.</li> </ul>	<ul style="list-style-type: none"> <li>A. Ensure filter pan is fully inserted into fryer. If the controller displays a "P" the pan is not fully engaged into the pan switch.</li> <li>B. Ensure the oil level is above the top oil level sensor.</li> <li>C. Ensure the oil temperature is above 310F (154C).</li> <li>D. Replace filter relay with part number 8074482 24VDC relay if defective.</li> <li>E. Press filter motor thermal switch.</li> <li>F. Set Filter in recipe setup to ON.</li> <li>G. Set Filter After to required number of cooks for filter prompt.</li> <li>H. Set Filtration Lockout for DISABLED.</li> <li>I. Ensure that no error exist in system. Check error log for errors. Power cycle the fryer.</li> </ul>
<b>No power present at the FIB board</b>	See No Power to FIB board in section 1.19.2.	See No Power to FIB board in section 1.19.2.
<b>Fryer filters after each cook cycle.</b>	Filter after setting incorrect.	Change or overwrite the filter after setting by re-entering the filter after value in Manager Settings, Filter Attributes in section 1.8 in the FQ4000 IO Manual.
<b>FIB will not clear error.</b>	Error remains in non-volatile memory.	Press home button. Press service. Press service again. Enter 3000 and press check. Press down arrow button. Press FIB2 reset. Press yes. Press the check. Press home button to exit. Ensure that at CHANGE FILTER the pan is out for at least 30 seconds to clear message.
<b>FQ4000 displays FILTER BUSY.</b>	<ul style="list-style-type: none"> <li>A. Another filtration cycle or filter envelope change is still in process.</li> <li>B. Filter interface board has not cleared checking system.</li> </ul>	<ul style="list-style-type: none"> <li>A. Wait until the previous filtration cycle ends to start another filtration cycle or until the FIB board has reset. This may take up to one minute. Change filter envelope if prompted.</li> <li>B. Wait 15 minutes and try again. If filter busy is still displayed with no activity, ensure the filter pan is empty and remove and restore <b>ALL</b> power to the fryer.</li> </ul>
<b>Drain valve or return valve stays open.</b>	<ul style="list-style-type: none"> <li>A. Valve Interface Board has failed.</li> <li>B. Actuator has failed.</li> <li>C. Power supply failed.</li> </ul>	<ul style="list-style-type: none"> <li>A. Ensure that the VIB and FIB board software versions are present to indicate communication.</li> <li>B. Ensure the actuator is properly connected and functioning.</li> <li>C. Ensure power supply is functioning correctly in Transformer Box. Check VIB for proper voltages using pin position chart in section 1.22.2.</li> </ul>
<b>Filter pump won't start or pump stops during filtering.</b>	<ul style="list-style-type: none"> <li>A. Power cord is not plugged in or circuit breaker is tripped.</li> <li>B. Pump motor has overheated causing the thermal overload switch to trip.</li> <li>C. Blockage in filter pump.</li> </ul>	<ul style="list-style-type: none"> <li>A. Verify that the power cord is fully plugged in and the circuit breaker is not tripped.</li> <li>B. If the motor is too hot to touch for more than a few seconds, the thermal overload switch has probably tripped. Allow the motor to cool at least 45 minutes then press the Pump Reset Switch.</li> <li>C. Ensure filter pump is functioning properly and no blockages exist.</li> </ul>
<b>FQ4000 displays INSERT PAN.</b>	<ul style="list-style-type: none"> <li>A. Filter pan is not fully set into fryer.</li> <li>B. Missing filter pan magnets.</li> <li>C. Defective filter pan switch.</li> </ul>	<ul style="list-style-type: none"> <li>A. Pull filter pan out and fully reinsert into fryer. Ensure controller does not display "P".</li> <li>B. Ensure the filter pan magnets are in place and replace if missing.</li> <li>C. If the filter pan magnets are fully against the switch and controller continues to display INSERT PAN or "P", switch is possibly defective.</li> </ul>
<b>Filter Pump runs, but oil return is very slow.</b>	<ul style="list-style-type: none"> <li>A. Clogged filter envelope.</li> <li>B. Improperly installed or prepared filter pan components.</li> <li>C. Pre-filter screen may be clogged or not fully tightened.</li> </ul>	<ul style="list-style-type: none"> <li>A. Ensure the filter is not clogged. If so, replace the filter.</li> <li>B. Remove the oil from the filter pan and replace the filter envelope. Verify that O-rings are present and in good condition on filter pan connection fitting.</li> <li>C. Clean pre-filter and ensure it is tightened with the attached wrench. Ensure the O-ring is present on the pre-filter.</li> </ul>

Problem	Probable Causes	Corrective Action
<b>FQ4000 displays IS DRAIN CLEAR?</b>	A. Clogged drain or float switch is malfunctioning. B. Dirty float switch.	A. The float switch detects that oil is not draining possibly due to clogged drain. Ensure drain is not clogged. If drain is not clogged, see float switch troubleshooting in section 1.22.5.1. B. Clean the float switch. Ensure when removing the float switch that its position is clearly marked and replaced properly. Installing the float upside down will change the switch from N/O to N/C. This could allow the empty frypot to ignite.
<b>FQ4000 displays E43 FLOAT SWITCH FAIL CALL SERVICE.</b>	Float switch sensor may have failed.	Ensure the float switch sensor is operating correctly.

### 1.19.3 FIB (Filter Interface Board) Filtration and Top-off Pin Positions and Harnesses

**NOTE: DO NOT CHECK WITH HARNESSES UNPLUGGED AS SHORTING THE PINS MAY OCCUR WHICH WILL DAMAGE THE BOARD.**

Connect or	From/To	Harness #	Pin #	Function	Voltage	Wire Color
J1	Input from Power Supply	8076450	1	Ground -		Brown
			2	24VDC Input	+24VDC	Purple
			3	Ground -		Brown
			4	24VDC Input	+24VDC	Purple
	Filter Pump Relay		9	Pump Motor +	24VDC	Purple
			10	Pump Motor -		Brown
	Pan Switch		13	Pan Sw Ground -	3.3VDC	Red
			14	Pan Sw +		Red
	Input from 24VAC Transformer		17	24VAC	24VAC	Orange
			18	24VAC Ret		Blue
	Waste Closed Switch		25	Closed Switch +	3.3VDC	Black
			26	Closed Switch Ground -		Black
Waste Open Switch	27	Open Switch +	3.3VDC	Black		
	28	Open Switch Ground -		Black		
J2	24VDC Power Output from FIB to VIB Board (J4) (RJ45)	8076315	1	Ground		
			2	Ground		
			3	Ground		
			4	Ground		
			5	Power	+24VDC	
			6	Power	+24VDC	
			7	Power	+24VDC	
			8	Power	+24VDC	
J3	C-Bus from far-right SIB Board (J8) (RJ11)	8076341	1	5VDC	+5VDC	
			2	CAN High		
			3	CAN Low		
			4	Ground		
J4	C-Bus from SIB (J8) or Network Resistor (pins 2 & 3) (RJ11)	(8075549 to next vat or 8075632 resistor)	1	5VDC+	+5VDC	
			2	CAN High		
			3	CAN Low		
			4	Ground		

## 1.19.4 Replacing the FIB Board Power Supply, Filter Pump Motor Relay or Transformer

See section 1.15.2 for instructions to replace the FIB board.

### 1.19.4.1 FIB (Filter Interface Board) LED's and Test Points

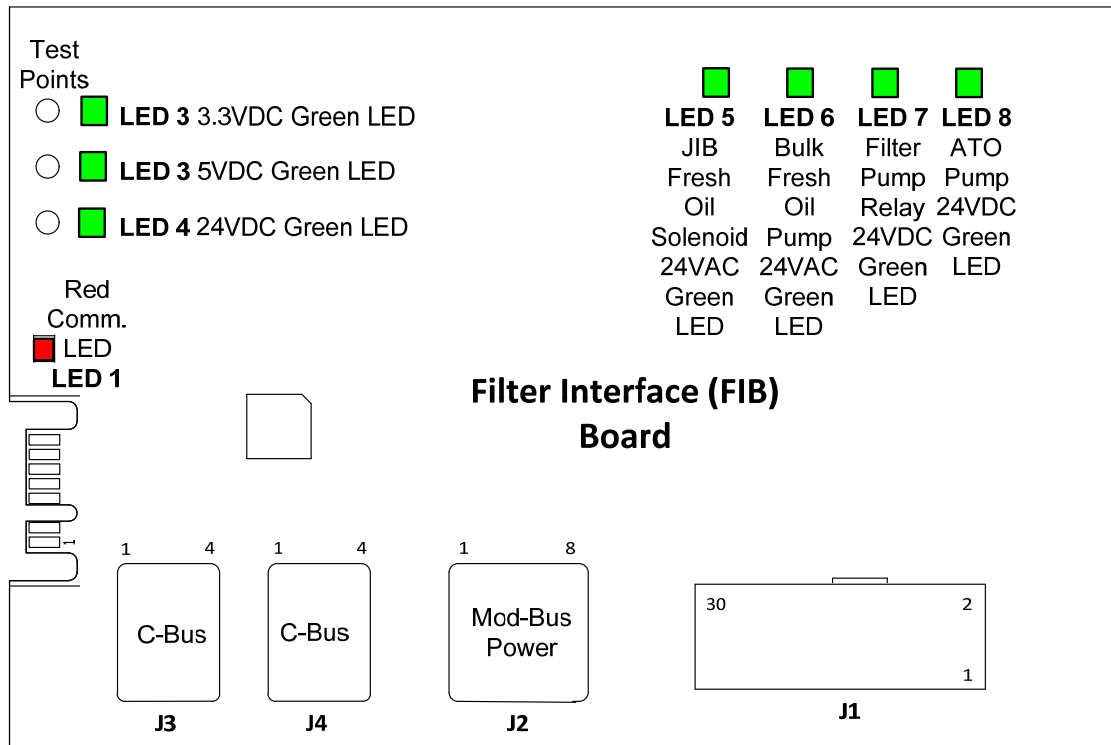

Figure 42

## 1.20 FIB (Filter Interface Board) Service Procedures

The controller has a service mode that allows manually opening of return and drain valves and manual operation of the filter pump motor.

To access the mode, follow these steps:

1. Press the Home button.
2. Press the Service button.
3. Press the Service button again.
4. Enter 3000 and press the checkmark.
5. Press Manual Filtration button.

The controller displays the current state of the valves and pump under the titles (see Figure 44). Pressing the buttons will perform the action inside the button.

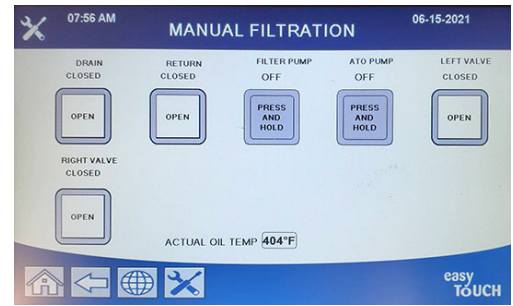

Figure 44

### 1.20.1 Manually Draining, Refilling, or Filtering using the Manual Filtration Mode

Pressing the drain button or the return button activates the drain or return valves for the associated vat. Pressing the filter pump button activates the pump. **NOTE: The pump will not activate unless a return valve is opened to prevent deadheading of the pump.**

Pressing the home button exits the manual filtration mode. Upon exiting the manual filtration mode, the controller will prompt to FILL VAT FROM PAN? YES/NO to ensure no oil is left in the filter pan. Follow the prompts to ensure all oil is returned to the vat.

### 1.20.2 Control Power Reset Switch

The control power reset switch, is a momentary rocker switch, located in the far-left fryer cabinet (see Figure 45), that resets all power to all the controllers and boards in the fryer. It is necessary to reset all power after replacing any controller or board and after any setup change. Press and hold the switch for at least **sixty (60) seconds** when resetting the control power to ensure power has sufficiently drained from boards.



Figure 45

## 1.22 VIB (Valve Interface Board) Service Procedures

The VIB (Valve Interface Board) controls the actuators that open and close the drain and return valves. The VIB board is located inside a protective housing under each frypot (see Figure 48).



Figure 48

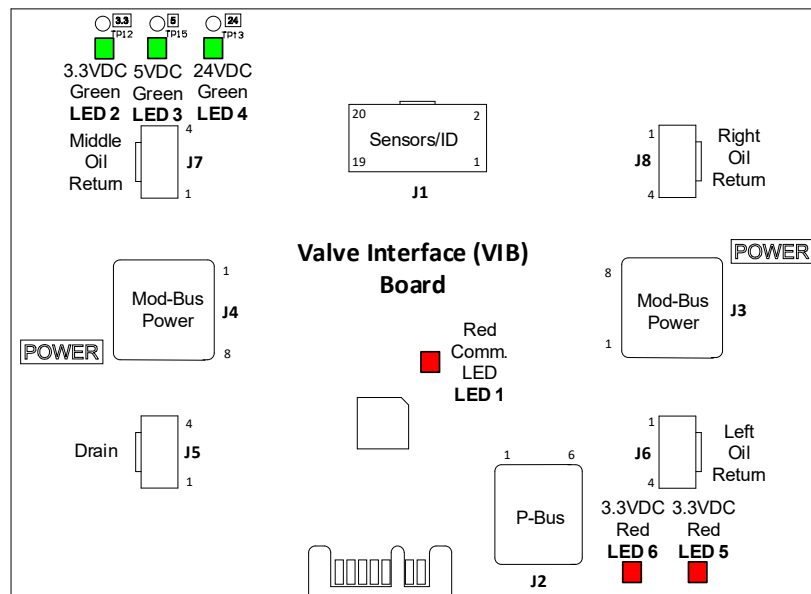

Figure 49

### 1.22.1 VIB (Valve Interface Board) Troubleshooting

**NOTE: DO NOT CHECK WITH HARNESES UNPLUGGED AS SHORTING THE PINS MAY OCCUR WHICH WILL DAMAGE THE BOARD.**

Problem	Probable Causes	Corrective Action
<p><b>Actuator doesn't function.</b></p>	<p>A. No power to the VIB board.            B. Actuator is unplugged.            C. VIB/FIB board failure.            D. Actuator voltage is incorrect.            E. Actuator is defective.</p>	<p>A. Check pins 4 and 5 of J2 at the FIB board. Should read 24VDC. Check voltage on pins 4 and 5 at the other end of harness and ensure 24VDC is present. Continue to check pins 4 and 5 for 24VDC on plugs J3 and J4 on the VIB boards.</p> <p>B. Ensure the actuator is plugged into the proper connection (J7 for Middle Oil Return, J8 for Right Oil Return, J6 for Left Oil Return and J5 for Drain).</p> <p>C. Check the DC voltage with the actuator plugged in on the connector of the problem actuator while trying to manually open or close an actuator. <b><u>DO NOT CHECK WITH ACTUATOR UNPLUGGED AS SHORTING THE PINS MAY OCCUR WHICH WILL DAMAGE THE BOARD.</u></b> Pins 1 (Black) and 4 (White) should read +24VDC when the actuator is opening. Pins 2 (Red) and 4 (White) should measure -24VDC when the actuator is closing). If either voltage is missing, the VIB board or FIB board is likely bad. Test the actuator by plugging into another connector. If the actuator operates, replace the VIB board.</p> <p>D. Check the DC voltage with the actuator plugged in between pin 3 (blue wire) and pin 4 (white wire). <b><u>DO NOT CHECK WITH ACTUATOR UNPLUGGED AS SHORTING THE PINS MAY OCCUR WHICH WILL DAMAGE THE BOARD.</u></b> Closed = below 0.825VDC and above 4mv. Open = Below 2.475V and above 0.825VDC. The voltage is out of tolerance and will have failure status if values are above 2.475VDC or less than 4mv.</p> <p>E. If proper voltages are present at the connector and actuator doesn't operate reset power to the fryer. If it still doesn't operate, replace the actuator.</p>
<p><b>Actuator functions on wrong vat or wrong valve.</b></p>	<p>A. Actuator plugged into wrong connector.</p>	<p>A. Ensure the actuator is plugged into correct connection (J7 for Middle Oil Return, J8 for Right Oil Return, J6 for Left Oil Return and J5 for Drain).</p>



## 1.22.2 VIB (Valve Interface Board) Actuator Board Pin Positions and Harnesses

**NOTE: DO NOT CHECK WITH HARNESSES UNPLUGGED AS SHORTING THE PINS MAY OCCUR WHICH WILL DAMAGE THE BOARD.**

Connector	From/To	Harness PN	Pin #	Function	Voltage	Wire Color			
J1	VIB (AIF) Probes, Float Switch, Time Delay Relay	8076448 8263287 VIB (AIF) Probe Only	1	VIB (AIF) Probe Ground	Ohm	Yellow			
			2	VIB (AIF) Probe		Red			
			3	N/A					
			4	N/A					
			5	Time Delay Relay Board		White			
			6	Time Delay Relay Board Gnd		Green			
			7	N/A					
			8	N/A					
			9	Float Switch +	24VDC	Red			
			10	Float Switch -		Black			
						11	N/A		
						12	N/A		
						13	Ground		
						14	24VDC +	24VDC	
J2	P-Bus Power Communication from SIB (RJ11)	8075555	1	Ground					
			2	P-BUS power	+5VDC				
			3	Modbus RS485 B					
			4	Modbus RS485 A					
			5	Signal ground					
			6	P-BUS power	+12VDC				
J3	24VDC Power Input between VIB Boards (RJ45)	8075810 between VIB boards	1	Ground					
			2	Ground					
			3	Ground					
			4	Ground					
			5	Power	+24VDC				
			6	Power	+24VDC				
			7	Power	+24VDC				
			8	Power	+24VDC				
J4	24VDC Power Output between VIB Boards (RJ45)	8076315 from FIB board or 8075810 between VIB boards	1	Ground					
			2	Ground					
			3	Ground					
			4	Ground					
			5	Power	+24VDC				
			6	Power	+24VDC				
			7	Power	+24VDC				
			8	Power	+24VDC				
J5	Drain Valve		1	Drain + (Open)	+24VDC	Black			
			2	Drain - (Closed)	-24VDC	Red			
			3	Drain Position		Blue			
			4	Ground		White			
J6	Left Return Valve		1	Ret + (Open)	+24VDC	Black			
			2	Ret - (Closed)	-24VDC	Red			
			3	Ret Position		Blue			
			4	Ground		White			
J7	Middle Return Valve		1	Ret + (Open)	+24VDC	Black			
			2	Ret - (Closed)	-24VDC	Red			
			3	Ret Position		Blue			
			4	Ground		White			
J8	Right Return Valve		1	Ret + (Open)	+24VDC	Black			
			2	Ret - (Closed)	-24VDC	Red			
			3	Ret Position		Blue			
			4	Ground		White			

### 1.22.3 Replacing a VIB (Valve Interface Board)

Disconnect the fryer from the electrical power supply. Locate the VIB (valve interface board) to be replaced under a frypot. Mark and unplug the location of the harnesses. The VIB assembly is held in place with one screw (see Figure 50). Remove the screw and the assembly drops down (see Figure 51) and the tab slides out of the bracket attached to the frypot (see Figure 52). Reverse steps to reassemble, ensuring that the new VIB assembly slides into the slot in the bracket. Once complete, **CYCLE POWER TO ENTIRE FRYER SYSTEM**. See section 1.20.2 to reset control power. Check software version # and if necessary, update the software. If a software update is necessary, follow the instructions to update the software in section 1.24.

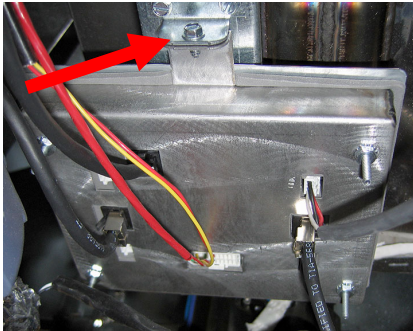

Figure 50

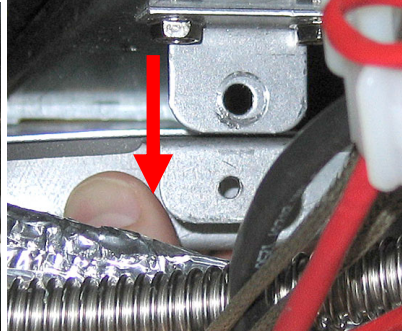

Figure 51

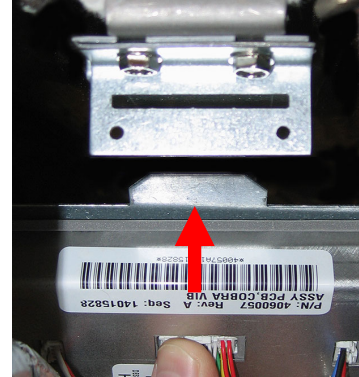

Figure 52

### 1.22.4 Replacing a Rotary Actuator

Disconnect the fryer from the electrical power supply. Locate the actuator to be replaced and mark and unplug the actuator. The actuators are held in place by two Allen screws (see Figure 52A). Loosen the Allen screws. Remove the actuator from the valve stem. Align the actuator with the valve stem and attach the new actuator. Tighten the two Allen screws. Reconnect power and test the actuator.

**NOTE:** Rotary actuators have two different part numbers which are also color coded (blue and black), which are mirror images of each other that correspond to their mounting position.

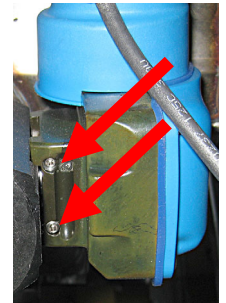

Figure 52A

### 1.22.5 Float Switch

The float switch is a safety device that is used to prevent operation of the burners when the oil level is low (see Figure 53). The float switch moves up and down a rod to detect the oil level in the frypot. When the oil level is low, it opens the circuit that has the 24VDC power from the VIB board to the time delay relay board, turning off the gas valve. The time delay relay board is in the control box next to the Smart Interface Board (SIB) (see Figure 54). The 24VDC to the FIB board is supplied from the power supply in the transformer box. It travels from J2 on the FIB board to J4 on the VIB board. The time delay relay coil is controlled by the 24VDC from the VIB board on J1 pins 9 and 10. The contacts closure of the time delay relay board is detected on pin 6 of the time delay relay board and pin 5 provides the ground.



Figure 53

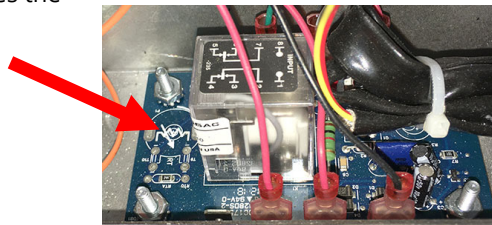

Figure 54

### 1.22.5.1 Float Switch Troubleshooting

#### Typical Sensor Related Failures

-E65 in the error log.

If the controller continues to display E65; the vat is full of oil; it does not heat, and gas supply, gas valve, etc. have been checked and no heat indicator illuminates because no call for heat is initiated, then follow these steps:

- Check (see diagram below)
  - Ensure the float switch can move freely up and down the rod. If not, use a no scratch pad to remove any buildup that is restricting movement of the float. Ensure when removing the float switch that its position is clearly marked and replaced properly. Installing the float upside down will change the switch from N/O to N/C. This could allow the empty frypot to ignite.
  - A common E65 error occurs if the float switch is not satisfied. If the float switch is clean and in the upper position and the vat is full, the time delay relay board relay may be the cause. Replace the time delay relay board.
  - Power to the FIB board from the power supply in the transformer box. Check for 24VDC.
  - Power to heater/relay coil on relay board. Check voltage to the coil between pins 8 and 1 to ensure that 24VDC is present with oil in the vat.
  - Check voltage between pin 3 and 2 on the time delay relay board. It should read 3.3VDC for air and 0VDC for oil. A common message for a shorted harness or issue is "IS DRAIN CLEAR?" with oil in the filter pan. Low voltage on these pins may cause E65 errors due to time delay relay board issues. Replace the time delay relay board.
  - Check VIB harness on J1. Interrupted communication will prevent the fryer from heating.

### 1.22.5.2 Float Switch Sensor Time Delay Relay Wiring Diagram

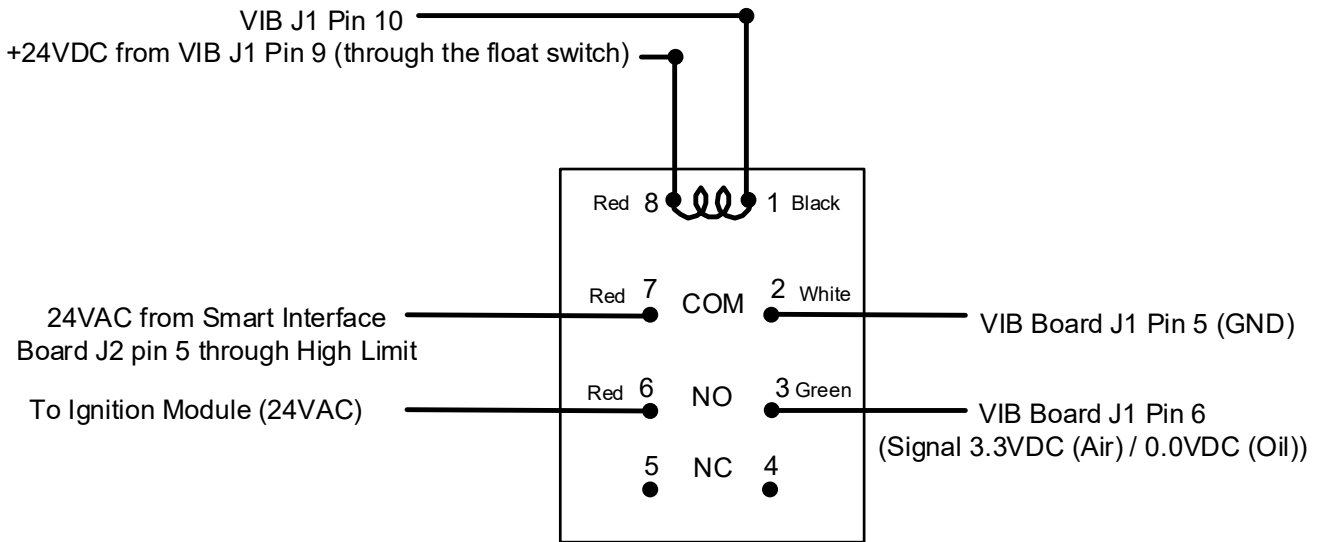

**Time Delay Relay Board  
DPDT 3.5 sec.**

**Figure 55**

## 1.23 FQ4000 Controller Service Procedures

### 1.23.1 FQ4000 Controller Troubleshooting

Problem	Probable Causes	Corrective Action
<b>No Display on Controller.</b>	<ul style="list-style-type: none"> <li>A. No power to the fryer.</li> <li>B. Controller has failed.</li> <li>C. Damaged controller wiring harness.</li> <li>D. Power supply component or SIB (Smart Interface Board) has failed.</li> <li>E. Shorted or melted harness from VIB to SIB.</li> </ul>	<ul style="list-style-type: none"> <li>A. Verify the power cord is plugged in and that circuit breaker is not tripped.</li> <li>B. Swap the controller with a controller known to be good. If controller functions, replace the controller.</li> <li>C. Swap with a harness known to be good. If controller functions, replace the harness.</li> <li>D. If any component in the power supply system (including the transformer and SIB Smart Interface Board) fail, power will not be supplied to the controller and it will not function.</li> <li>E. Check the harness from J2 on the VIB board to J10 on the SIB board. Inspect for heat damage and routing of harness close to the frypot. Inspection of the green LED's (LED 2, LED 4 and LED 6) on the SIB board should be brightly illuminated. If the green LED's are either blinking or dim or the harness is damaged, replace the harness (8075555).</li> </ul>
<b>Controller locks up.</b>	Controller error.	Remove and restore power to the fryer (controller).
<b>FQ4000 displays E45 RECOVERY FAULT.</b>	Recovery time exceeded maximum time limit for two or more cycles.	Silence the alarm by pressing the check button. Check that fryer is heating properly. Maximum recovery is 4:00. See Section 1.16.4 for an explanation of recovery time and section 1.16.2 Improper Burner Function. Reset the error code by going to: HOME -> SERVICE -> SERVICE ->3000-> TECH MODE -> RESETS -> RECOVERY FAULT CALL SERVICE -> YES.
<b>FQ4000 displays E61 MISCONFIGURED ENERGY TYPE</b>	Wrong energy type selected in service settings.	Press home button. Press Settings button. Press Service button again. Enter 3000. Press Energy Type and select correct energy type.
<b>FQ4000 displays UNABLE TO READ USB DRIVE</b>	<ul style="list-style-type: none"> <li>A. Defective USB drive</li> <li>B. Improper format of USB drive</li> <li>C. Wrong USB port</li> <li>D. Swapped USB port extensions.</li> </ul>	<ul style="list-style-type: none"> <li>A. Replace USB drive.</li> <li>B. Ensure the USB drive is formatted to FAT 32.</li> <li>C. Ensure the USB drive is inserted into the USB port under the power reset switch.</li> <li>D. Ensure the USB port extension under the power reset switch is plugged into the far-left controller USB port on the rear of the controller.</li> </ul>
<b>FQ4000 displays FILE NOT FOUND</b>	<ul style="list-style-type: none"> <li>A. Missing files on USB drive</li> <li>B. Incorrect file name</li> <li>C. Wrong USB port</li> <li>D. Swapped USB port extensions.</li> </ul>	<ul style="list-style-type: none"> <li>A. Ensure correct files are on USB drive.</li> <li>B. Ensure the file is correctly named. If using a CBR menu file, the file name can <b>ONLY</b> be 8 characters or less.</li> <li>C. Ensure the USB drive is inserted into the USB port under the power reset switch.</li> <li>D. Ensure the USB port extension under the power reset switch is plugged into the far-left controller USB port on the rear of the controller.</li> </ul>
<b>FQ4000 displays SOFTWARE UPDATE CANCELLED - RESTART THE SYSTEM</b>	<ul style="list-style-type: none"> <li>A. USB drive removed during software update.</li> <li>B. Power loss during a software update.</li> </ul>	<ul style="list-style-type: none"> <li>A. Restart the system and reload the software ensuring that the USB drive is not removed until prompted to do so.</li> <li>B. Reload the software from USB drive.</li> </ul>
<b>QUICK FILTER or CLEAN AND FILTER won't start.</b>	Temperature too low.	Ensure fryer is at 310F (154C) before starting <b>QUICK FILTER</b> or <b>CLEAN AND FILTER</b> .
<b>FQ4000 displays SERVICE REQUIRED with the type of error.</b>	An error has occurred.	Press YES to silence alarm. The error is displayed three times. See list of issues in section 1.4. Fix issue. The controller displays <b>SYSTEM ERROR FIXED? YES/NO</b> . Press YES. Controller displays <b>ENTER CODE</b> . Enter <b>1111</b> to clear error code. Pressing <b>NO</b> will allow the fryer to cook <b>but error will be redisplayed every 15 minutes</b> .
<b>FQ4000 display is in wrong temperature scale (Fahrenheit or Celsius).</b>	Incorrect display option programmed.	Press home button. Press Service button. Press Service button again. Enter 3000. Press Tech Modes. Press Toggle to Select. Press F° to C° to toggle temperature scale. Press YES to confirm. Press check to complete. Press home to exit.

Problem	Probable Causes	Corrective Action
<b>FQ4000 displays VAT ID CONNECTOR NOT CONNECTED</b>	Vat ID locator connector unplugged from rear of touch screen or grounded position in control box.	Ensure that the vat locator connector is properly connected to touch screen harness and ensure that ground on harness is properly grounded to control box.
<b>FQ4000 displays NO MENU GROUP AVAILABLE FOR SELECTION</b>	All menu groups have been deleted.	Create a new MENU group or reload menu files. Once a new menu is created, add recipes to the group (see section 4.11 of the IO manual).
<b>FQ4000 displays CHANGE FILTER PAD.</b>	Filter error has occurred, filter envelope clogged, 24-hour filter change prompt has occurred or change filter was ignored on a prior prompt.	Change the filter envelope and ensure the filter pan has been removed from the fryer for a minimum of <b>30</b> seconds. Do <b>NOT</b> ignore <b>CHANGE FILTER PAD</b> prompts.
<b>FQ4000 displays E16 HIGH LIMIT 1 EXCEEDED.</b>	Frypot temperature is more than 410°F (210°C) or, in CE countries, 395°F (202°C).	This is an indication of a malfunction in the temperature control circuitry, including a failure of the high-limit thermostat during normal operation.
<b>FQ4000 displays E17 HIGH LIMIT 2 EXCEEDED.</b>	Frypot temperature is high enough to open the physical bi-metallic high limit switch or the switch has failed.	This is displayed when the oil temperature is above 425°F (218°C) and the high-limit thermostat has opened, halting the heating of the oil. Let the high limit cool to determine if the switch closes. Check high limit resistance.
<b>FQ4000 displays E18 HIGH LIMIT PROBLEM – DISCONNECT POWER – CALL SERVICE.</b>	Failed high limit.	This is displayed to indicate the high limit has failed.
<b>FQ4000 displays HOT-HI 1.</b>	Controller in high-limit test mode.	This is displayed only during a test of the high-limit circuit and indicates that the frypot temperature is more than 410°F (210°C) or, in CE countries, 395°F (202°C).
<b>FQ4000 displays HELP HI-2.</b>	Controller in high-limit test mode.	This is displayed only during a test of the high-limit circuit and indicates that the high-limit has opened properly.
<b>FQ4000 displays HIGH LIMIT FAILURE DISCONNECT POWER.</b>	Controller in high-limit test mode. Failed high limit.	This is displayed during a test of the high limit to indicate the high limit has failed.
<b>FQ4000 displays INSERT PAN.</b>	A. Filter pan is not fully inserted into fryer. B. Missing filter pan magnet. C. Defective filter pan switch.	A. Pull filter pan out and fully reinsert into fryer. B. Ensure the filter pan magnet is in place and if missing replace. C. If the filter pan magnet is fully against the switch and controller continues to display <b>INSERT PAN</b> , switch is possibly defective.
<b>FQ4000 displays MELT CYCLE IN PROGRESS.</b>	Frypot temperature is below 180°F (82°C).	This display is normal when the fryer is first turned on while in the melt cycle mode. To bypass the melt cycle press <b>BYPASS MELT CYCLE</b> button next to the <b>PREHEAT</b> . The controller displays <b>PREHEAT</b> while heating to setpoint. If the display continues, the fryer is not heating.
<b>FQ4000 displays PREHEAT.</b>	Frypot temperature is above 180°F (82°C).	This display is normal when the fryer is above 180°F (82°C) but below setpoint. If the display continues, the fryer is not heating. Clean the float switch sensor. Ensure when removing the float switch that its position is clearly marked and replaced properly. Installing the float upside down will change the switch from N/O to N/C. This could allow the empty frypot to ignite.
<b>FQ4000 displays E13 TEMPERATURE PROBE FAILURE CALL SERVICE.</b>	A. Problem with the temperature measuring circuitry including the probe. B. Bad Connection	A. This indicates a problem within the temperature measuring circuitry. Check resistance of probe, if faulty replace probe. B. Ensure temperature probe is connected properly to SIB board. Ensure that the connector is terminated properly.
<b>FQ4000 displays E19 HEATING FAILURE</b>	A. Heat or latch circuit failed. B. SIB failure	A. Check the heat or latch circuit. B. Replace the SIB board.

Problem	Probable Causes	Corrective Action
<b>FQ4000 displays E65</b>	A. Low oil B. Dirty or stuck float switch.	The float switch does not detect oil. 1. Ensure the frypot is full of oil. 2. Float switch may be stuck up or down. 3. Clean the float switch.  Ensure the float switch moves freely up and down. Ensure when removing the float switch that its position is clearly marked and replaced properly. Installing the float upside down will change the switch from N/O to N/C. This could allow the empty frypot to ignite. If the switch is clean, the time delay relay board may be the issue.
<b>FQ4000 displays E28 HEATING FAILURE.</b>	Failed or closed gas valve, dirty blower, low micro amps, defective sensor wire, defective igniter/ignition cable, defective ignition module, improper gas pressure, failed SIB, or open high-limit thermostat.	Turn off the vat with the issue and back on again to see if issue corrects itself. The error is displayed if the fryer loses its ability to heat oil. This error comes from the alarm signal on the ignition module. It sometimes is seen when air is in the gas line.
<b>FQ4000 displays software version for only FQ4000, SIB, VIB or FIB but not all boards.</b>	Loose or damaged harness	Check that all harnesses between FQ4000's, SIB, VIB and FIB are secure. Check for loose or broken pins/wires. If the problem persists, swap out controller from one bank to another and see if the problem follows the controller. Power cycle the fryer.
<b>FQ4000 displays IS VAT FULL? YES NO.</b>	A. Normal operation during most at the beginning or end of most filtration functions. B. If the display appears many times during a filter, it could be an indication of slow oil return C. A filter error has occurred due to dirty or clogged filter envelope, clogged pre-filter, clogged filter pump, filter pump thermal overload, improperly installed filter pan components, worn or missing O-rings, cold oil or an actuator problem.	A. Ensure the vat is full of oil and press the √ button. B. See section 1.19.2 troubleshooting – Filter Pump runs, but oil return is very slow. C. Ensure the filter envelope is clean, pre-filter is clean; O-rings are present and not worn; filter pump overload is not tripped.

### 1.23.1.1 FQ4000 Controller Functional Troubleshooting

There are four (4) LED status lights on the rear of the controller which provide a quick method to verify power and touch screen functionality on the FQ4000 controller.

To verify that the FQ4000 has power and the touch screen is functional, remove the 2 screws attaching the controller to the bezel. Lower the controller to view the LED's on the rear of the controller board. Verify that the three (3) green LED's are illuminated which indicate that 3V, 5V and 12V power is present on the controller. These should always be illuminated. Pressing anywhere on the front of the touch screen will illuminate the red LED STATUS (see photo below). The red LED will also illuminate momentarily during power up.

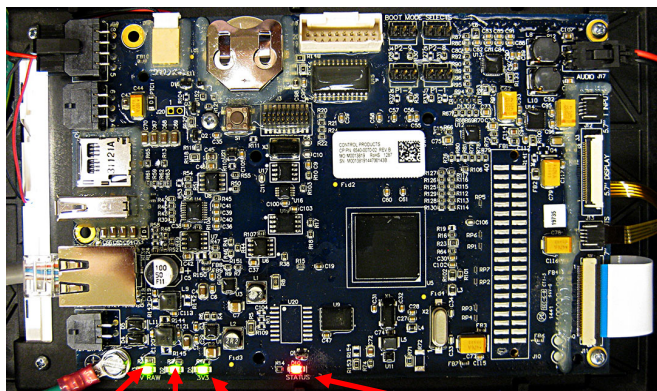

12V from SIB  
5V from SIB  
3V from power supply on UIB

When the touch screen is pressed the STATUS LED illuminates RED.



## 1.24 Loading and Updating Software/Menu Procedures

Updating the software takes approximately 30 minutes. The software only needs to be loaded in the USB port in the far-left fryer cabinet and it will update **ALL** the controllers and boards in the system. To update the software, follow these steps carefully.

### Step 1 – Check Product Availability

Ensure enough products are cooked to cover 30 minutes of operations while the fryer is updating.

### Step 2 – Power Cycle the Fryer

To power cycle the system, **PUSH and HOLD** the black toggle reset switch for **60 SECONDS**. The reset switch is located either under the far-left USB port (see photos to the right). If the switch is not accessible, unplug the fryer or turn off the breaker to the fryer.











### Step 3 – Pull the Filter Pan

Pull the filter pan slightly out from the cabinet until a "P" is visible on the top right corner of the display.





### Step 4 – Turn OFF Fryers

Press the power button  on each display to ensure **ALL** controllers are **OFF**.

### Step 5 – Reset the fryer on the Left Screen

- On the left screen, press  →  →  → 3000 →  →  FIB-RESET 2 → YES
- RESET COMPLETED SUCCESSFULLY** is displayed once the reset is complete. Press  →  →  CREW MODE
- If a CAN COMMUNICATION FAILED error occurs, see Troubleshooting on the last page.

### Step 6 - Update the software

- On the left screen, press  →  →  → 3000 →  → TECH MODES →  SOFTWARE UPGRADE
- INSERT USB.** The USB port is located inside the **far-left cabinet, on the left-hand side**. Slide the cover up to reveal the USB port (see photos to the right).
- Follow the onscreen instructions.
- Press **YES** when the screen displays **CONFIRM CONTROLLERS AVAILABLE FOR UPGRADE UIB, SIB, VIB AND FIB - YES/NO** or **SOFTWARE UPDATE WILL TAKE APPROXIMATELY 30 MINUTES. YOU WILL NOT BE ABLE TO COOK DURING THIS TIME. CONTINUE WITH SOFTWARE UPDATES?**
- When the update has completed on **ALL** screens, press the **YES** button to confirm.
- Power cycle the system as shown in step 2 for **60 SECONDS**. **Failure to press and hold the reset switch long enough, may cause an incomplete software update.**
- After the power cycle, it may take a while for the displays to completely reboot. Once rebooted, the left screen may display **MENU UPGRADE REQUIRED**. The right screen will return to the **OFF** state. **DO NOT POWER ON! Powering on the fryer, prior to loading the MENU's, may disable the fryer!**

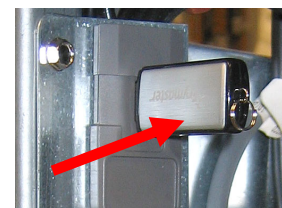
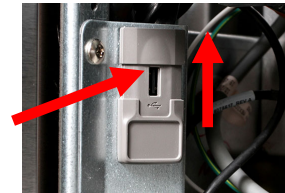

### Step 7 - Update the Menu

- The left screen displays **MENU UPGRADE REQUIRED**.
- On the left screen press  → **INSERT USB**.
- Insert the USB into the USB port.
- Configurations –
  - Most configurations are **Standard Left**.  
The menus are from left to right - **Left 3 Battery fryer:** Vat 1-Seafood, Vat 2- Fries, Vat 3- Spicy **Right 3 Battery fryer:** Vat 1(4) - Spicy, Vat 2 (5) – Mild, Vat 3 (6) – Mild
  - Some configurations are a **Mirror Configuration**  
The menus are from left to right - **Left 3 Battery fryer:** Vat 1- Mild, Vat 2- Mild, Vat 3- Spicy **Right 3 Battery fryer:** Vat 1(4) - Spicy, Vat 2 (5) – Fries, Vat 3 (6) – Seafood
- Follow onscreen instructions. Each menu file must be loaded individually to the appropriate vats by selecting the correct vat when prompted to **SELECT THE VATS FOR MENU UPGRADE**. Select **ONLY** the vats to be updated. Only Mild will be loaded to two vats at a time, by choosing 2 and 3 for Standard Left configurations or 1 and 2 for Mirror Configuration, when prompted to **SELECT THE VATS FOR MENU UPGRADE**.
  - When the update has completed on **ALL** screens, press the **YES** button to confirm.



- Remove the USB from the fryer.
- Slide the USB cover down to cover the port.

Push and hold the black toggle switch from step 3 for **60 SECONDS** to power cycle the system  
To update other vat menus, continue to Step 8, otherwise skip to Step 9.

### Step 8 – Manually Update the Menus on the other vats.

- On the left screen, press → → → 1656 → → USB - MENU OPERATION → → COPY MENU FROM USB TO FRYER
- Insert the USB into the USB port.
- Configurations –
  - Most configurations are **Standard Left**.  
The menus are from left to right - **Left 3 Battery fryer:** Vat 1-Seafood, Vat 2- Fries, Vat 3- Spicy **Right 3 Battery fryer:** Vat 1(4) - Spicy, Vat 2 (5) – Mild, Vat 3 (6) – Mild
  - Some configurations are a **Mirror Configuration**  
The menus are from left to right - **Left 3 Battery fryer:** Vat 1- Mild, Vat 2- Mild, Vat 3- Spicy **Right 3 Battery fryer:** Vat 1(4) - Spicy, Vat 2 (5) – Fries, Vat 3 (6) – Seafood
- Follow onscreen instructions. Each menu file must be loaded individually to the appropriate vats by selecting the correct vat when prompted to SELECT THE VATS FOR MENU UPGRADE. Select **ONLY** the vats to be updated. Only Mild will be loaded to two vats at a time, by choosing 2 and 3 for Standard Left configurations or 1 and 2 for Mirror Configuration, when prompted to SELECT THE VATS FOR MENU UPGRADE.
- When the update has completed on **ALL** screens, press the **YES** button to confirm.
- Ensure the USB is removed from the fryer.
- To power cycle the system, push and hold the black toggle switch from step 2 for **60 SECONDS**.
- Repeat steps 1-7 for additional menus. If complete, advance to next step.
- Slide the USB cover down to cover the port.

### Step 9 - Verify the software update on all displays.

- On **ALL** the screens, press → → → → SOFTWARE VERSION
- When the versions are displayed, confirm they all match the new software versions.
- If software versions match on **ALL** screens, press and proceed to **Step 10**.
- If software versions **DO NOT** match, press and repeat **Step 6 - Update the Software**.

### Step 10 – Reposition the Filter Pan

Push the filter pan back into the fryer until a “P” is **NOT** visible on the top right corner of the display.

### Step 11 – Verify Menu Update and Product location

- Power on all controllers.
- Wait for all vats to heat to setpoint and all product images are displayed.
- Press the menu button to advance from FRIES, SPICY, MILD, SEAFOOD.
- Ensure products and images are in each menu.
- If any current products or LTO (Limited Time Offers) are missing from menus, the products will need assigned to a location. Some products may need reprogrammed into each controller, as they may have been overwritten during the update.
- Follow the instructions below to change product location assignment.

**Changing a Product**

Press and hold the product button to change. The outline of the button changes from green to red and then to solid red. Select another product.

## 1.25 Software/Menu Update Troubleshooting

### CAN COMMUNICATION FAILED or CAN communication error during an update

1. Power cycle fryer ensuring that the reset switch is pressed and held for **60 seconds** or greater, or power is removed for **60 seconds** or greater.
2. Update the software or menus again.
3. Check software versions or menus. If they still do not update repeat step #1 and recheck.

### SOFTWARE UPGRADE IS grayed out

1. Ensure **ALL** controllers are **OFF**.
2. Ensure the user is trying to do the software upgrade on VAT #1. VAT #2, 3, 4, 5 will be grayed out, as software updates can **NOT** be performed on any controller other than VAT #1 controller.
3. Ensure the VAT ID locator wire is not loose.
4. Go to SOFTWARE VERSION on all the controllers and ensure that BOARD ID's are correct. VAT 1=1, VAT2=2, etc. If BOARD ID on VAT 1 is not 1 then a pin is in the wrong location in the 6-pin locator connector. It should be in the following position (see photo) for VAT 1.

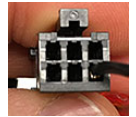

### Software or menus do not update

1. Ensure the USB is removed from the fryer. Power cycle fryer ensuring that the reset switch is pressed and held for **60 seconds** or greater, or power is removed for **60 seconds** or greater.
2. Recheck software versions or menus. If they still do not update repeat step #1 and recheck or reload software and menus.
3. If the message "USB UPGRADE FAILED" is displayed, press YES. Remove the USB drive. On the left screen press



4. Follow the onscreen instructions and ensure the USB is fully inserted into the USB drive.

### Menus only update to one fryer vat

1. Ensure that the appropriate vat(s) are selected at the prompt **SELECT THE VATS FOR MENU UPGRADE** when updating menus.

### Product Icons/Photos missing

1. Update the menu files again.
2. Power cycle fryer ensuring that the reset switch is pressed and held for **60 seconds** or greater, or power is removed for **60 seconds** or greater.
3. Check menus. If they still do not update repeat step #1 and recheck.

### Display reboots automatically during an update

1. Power cycle fryer ensuring that the reset switch is pressed and held for **60 seconds** or greater, or power is removed for **60 seconds** or greater.
2. Update the software or menus again.
3. Check software versions or menus. If they still do not update repeat step #1 and recheck.

### Controller keeps rebooting after an update

1. Ensure ALL controllers display OFF.
2. Update the menu files again.
3. Power cycle fryer ensuring that the reset switch is pressed and held for **60 seconds** or greater, or power is removed for **60 seconds** or greater.
4. Check menus. If they still do not update repeat step #1 and recheck.

### Change Filter message after an FIB2 Reset

1. This is normal after an FIB2 reset.
2. Pull the filter pan slightly out slightly of the cabinet until a "P" is visible on the top right corner of the display for **60 seconds** or greater until the message disappears.
3. Push the filter pan back into the fryer.

### Display locks up during an update

1. Power cycle fryer ensuring that the reset switch is pressed and held for **60 seconds** or greater, or power is removed for **60 seconds** or greater.
2. Update the software and menus again

# 1.26 Wiring Diagram FQG120T

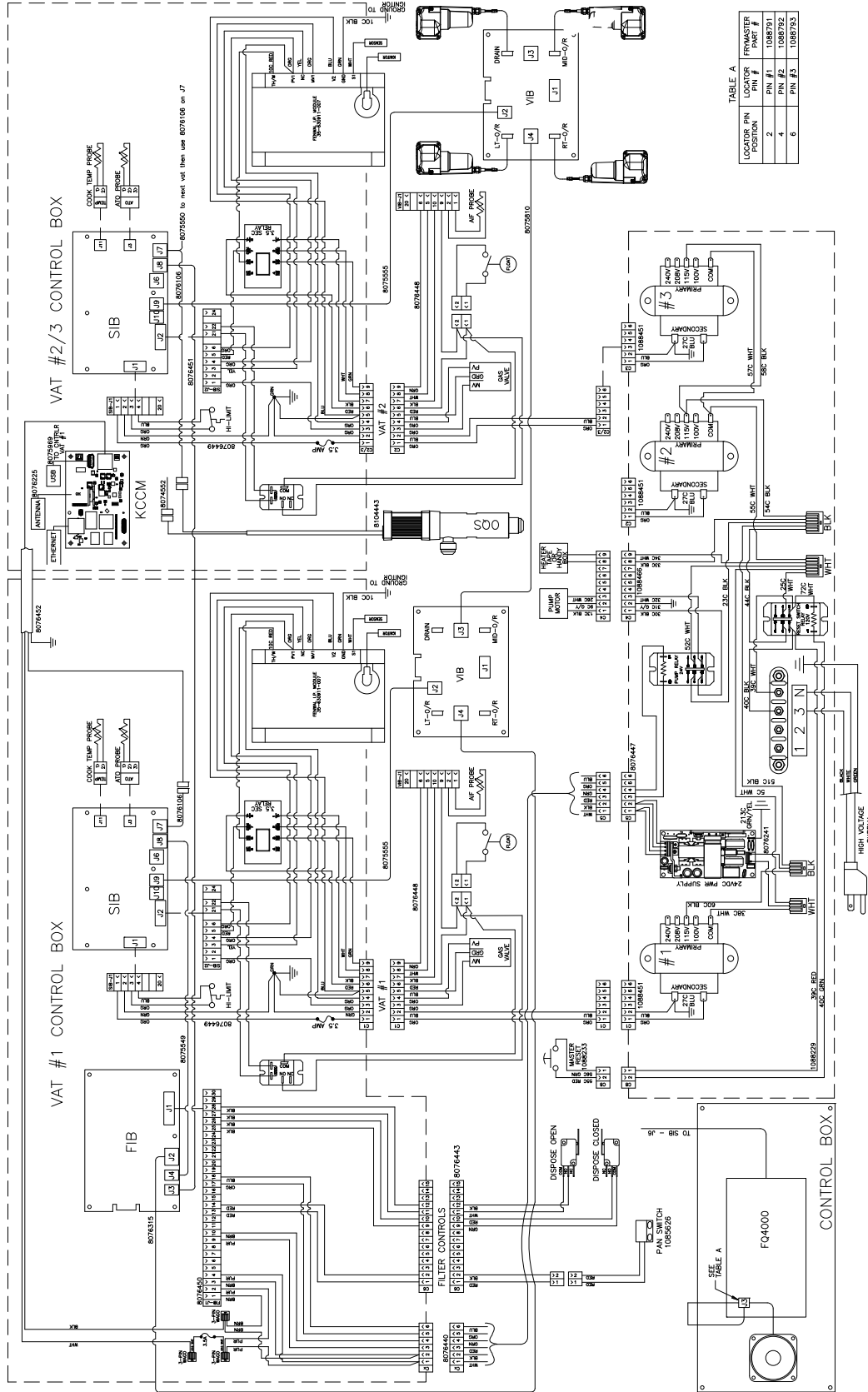
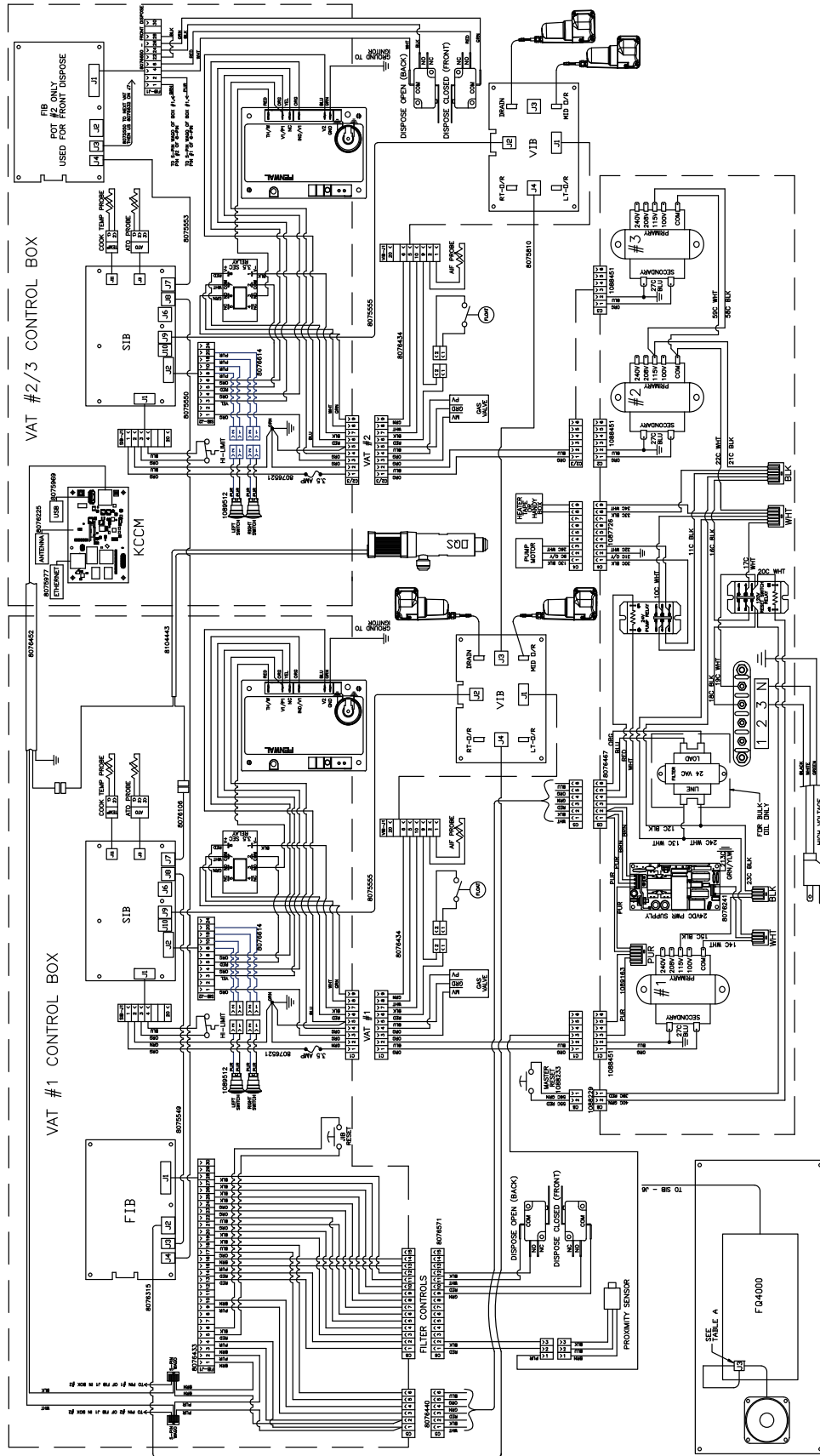

TABLE A

LOCATOR PIN POSITION	LOCATOR PIN #	FRYMASTER PART #
2	1	1085791
6	2	1085792
	3	1085793

8052208C

# 1.26.1 Wiring Diagram FQG80T w/Easy Button Start



8052259C

# 1.26.2 Wiring Diagram FQG100T CE

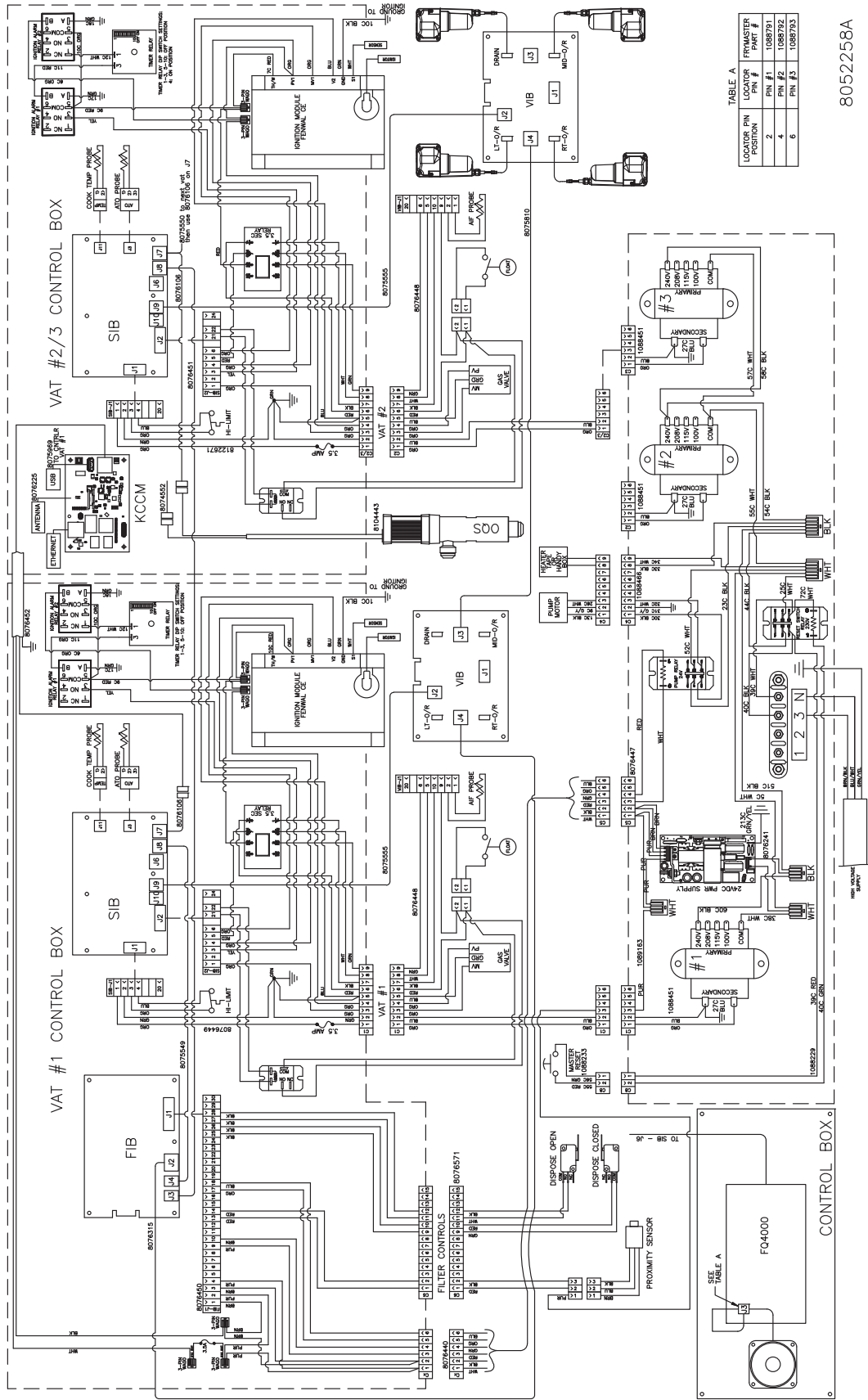

TABLE A







LOCATOR PIN POSITION	FRMASTER PART #
2	1086791
4	1086792
6	1086793

8052258A

## 1.27 High Limit Test

The high-limit test mode is used to test the high limit circuit. The high-limit test will destroy the oil. It should only be performed with old oil. Shut the fryer off and call for service immediately if the temperature reaches 460°F (238°C) without the second high-limit tripping and the controller displays HIGH LIMIT FAILURE DISCONNECT POWER with an alert tone during testing.

The test is cancelled at any time by turning the fryer off. When the fryer is turned back on, it returns to the operating mode and displays the product.

DISPLAY	ACTION
 	1. With the controller at the off/standby position, press the Home button.
	2. Press the Service button.
	3. Press the Crew button.
<b>9 0 0 0</b>	4. Enter <b>9000</b>
 	5. Select LEFT VAT or RIGHT VAT for split vats.
<b>PRESS AND HOLD</b>	6. Press and hold the Press and Hold button to begin high limit test.
<b>RELEASE</b>	7. While pressing and holding the button the vat begins to heat. The controller displays the actual vat temperature during the test. When the temperature reaches 410°F ± 10° F (210°C ± 12°C)*, the controller displays HOT HI-1 (ex. 410F) and continues heating. *NOTE: In controllers used in the European Union (those with the CE mark), the temperature is 395°F (202°C) when the controller displays HOT HI-1.
<b>HOT HI-1</b>	8. While continuing to press and hold the button, the fryer continues heating until the high limit opens. Generally, this happens once the temperature reaches 423°F to 447°F (217°C to 231°C) for non-CE high limits and 405°F to 426°F (207°C to 219°C) for CE high limits.
<b>HELP HI-2</b>	9. Release the button. The vat stops heating, and the controller displays the current temperature setting until the temperature cools below 400°F (204°C). Press the power button to cancel the alarm.
<b>HIGH LIMIT FAILURE DISCONNECT POWER</b>	10. If the controller displays this message, disconnect power to the fryer and immediately call for service.
	11. After a high limit test, once the vat cools below 400°F (204°C), dispose of the oil.



FRYMASTER  
8700 LINE AVENUE, SHREVEPORT, LA 71106-6800

---

800-551-8633  
318-865-1711

[WWW.FRYMASTER.COM](http://WWW.FRYMASTER.COM)

EMAIL: [FRYSERVICE@FRYMASTER.COM](mailto:FRYSERVICE@FRYMASTER.COM)

©2025 Frymaster LLC. except where explicitly stated otherwise. All rights reserved. Continuing product improvement may necessitate change of specifications without notice.

Part Number FRY\_SM\_8197955 04/2025

